

204P

Type: 52204

404P

Type: 52214

504P

Type: 52222

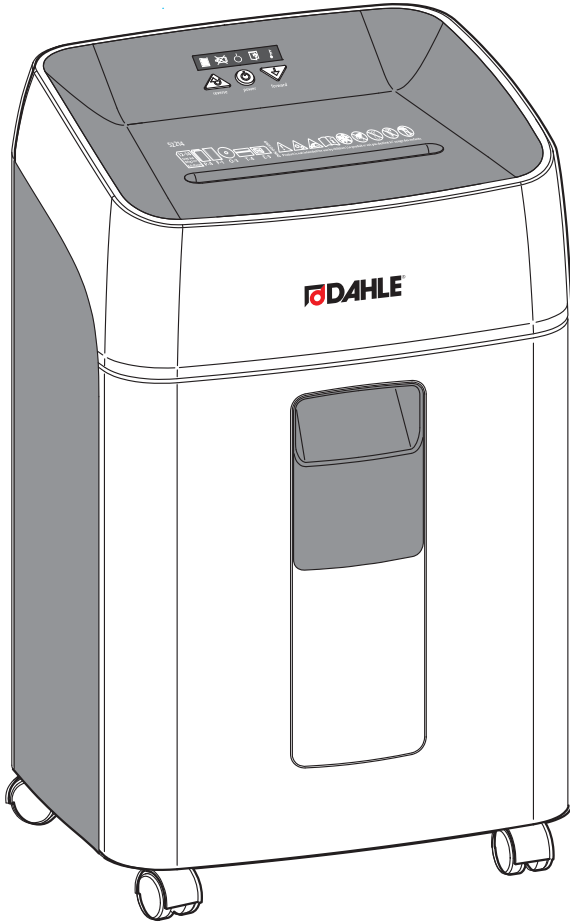



de	Originalgebrauchsanleitung.....	4
en	Instructions.....	7
fr	Mode d'emploi.....	10
es	Instrucciones.....	13
it	Istruzioni per l'uso.....	16
pt	Manual de instruções.....	19
nl	Gebruikershandleiding.....	22
da	Betjeningsvejledning.....	25
fi	Käyttöohje.....	28
no	Bruksanvisning.....	31
sv	Bruksanvisning.....	34
sl	Navodilo za uporabo.....	37
hr	Upute za uporabu.....	40
hu	Használati utasítás.....	43
ru	Инструкция по применению.....	46
et	Juhised.....	49
lt	Naudojimo instrukcija.....	52
lv	Lietošanas norādījumi.....	55
cs	Návod k použití.....	58
sk	Návod na použitie.....	61
pl	Instrukcja użytkowania.....	64
ro	Instrucțiuni de utilizare.....	67
bg	Указание за употреба.....	70
tr	Kullanım kılavuzu.....	73
el	Οδηγίες χρήσης.....	76
ar	تعليمات.....	79
ja	取扱説明書.....	82
zh	使用说明.....	85

de **Gebrauchsanleitung**



ACHTUNG!

Lesen Sie **VOR** Inbetriebnahme des Aktenvernichters die Gebrauchsanleitung und Sicherheitshinweise aufmerksam durch.



Die Hinweise müssen angewendet werden! Bewahren Sie die Gebrauchsanleitung für den späteren Gebrauch auf.

Inhaltsverzeichnis

1	Wichtige Informationen	4
1.1	Bestimmungsgemäße Verwendung, Gewährleistung	4
1.2	Sicherheitshinweise	4
1.3	Piktogrammlegende	5
1.4	Lieferumfang	88
1.5	Technische Daten	88
2	Bedienung	89
2.1	Transportsicherung entfernen	89
2.2	Gerät an das Stromnetz anschließen	90
2.4	Gerät einschalten	90
2.5	Papiervernichtung	91
2.8	Dauervorlauf	92
2.9	CD/DVD-, Kartenvernichtung	93
3	Wartung / Störungsbeseitigung	95
3.1	Schnittgut entleeren	95
3.3	Behälter öffnen	95
3.4	Überhitzung	96
3.6	Papierstau	96
3.7	Gerät reinigen	97
3.9	Gerät ölen	98

1.1 Bestimmungsgemäße Verwendung, Gewährleistung

Der Aktenvernichter ist zum Vernichten von Papier bestimmt.

Je nach Modellvariante kann außerdem eine geringe Menge folgender Materialien vernichtet werden:

- CDs/DVDs, Scheck- und Kreditkarten (siehe Technische Daten).
- die in Papierdokumenten, in anwendungsüblichem Umfang, vorhandenen Heft- und Büroklammern (Ausnahme: Geräte der Sicherheitsstufe P6 und P7).

Verschleiß, Schäden durch unsachgemäßen Gebrauch, sowie Eingriffe von dritter Stelle, fallen weder unter die Gewährleistung noch unter die Garantie.

Der Aktenvernichter ist für den Betrieb im privaten Bereich und normaler Büroumgebung konzipiert.

Bzgl. der unter technische Daten angegebenen Blattleistung gelten folgende Rahmenbedingungen:

Maximale Anzahl von Blättern, die in einem Durchgang unter folgenden Bedingungen geschnitten werden: Neue ggfs. geölte Schneidwalzen, kalter Motor, Stromversorgung mit Nennspannung und Nennfrequenz (230V/50Hz; 120V/60Hz).

Abweichungen können zu einer geringeren Blattleistung und zu erhöhten Laufgeräuschen führen.

Die Blätter werden mittig und längs unter 90° zugeführt. Je nach Papiereigenschaften und Zuführung kann die Blattleistung ebenfalls variieren.

1.2 Sicherheitshinweise

- Überprüfen Sie, dass die Spannung und Netzfrequenz Ihres Stromnetzes mit den Angaben auf dem Typenschild übereinstimmen.
- Das Gerät nicht in der Nähe einer Wärmequelle aufstellen!
- Das Gerät nur stehend lagern, transportieren und betreiben!
- Am Gerät nur Flüssigkeiten und Gase verwenden, welche den DAHLE-Richtlinien entsprechen!
- Das Gerät darf nicht geöffnet werden! Gefahr eines elektrischen Schlags!

- Das Gerät nur in geschlossenen Räumen, bei 10°C bis 25°C (50°F bis 77°F) und einer nichtkondensierenden Luftfeuchtigkeit von 15% bis 95% betreiben!
- Die Kurzschlussicherheit der Gebäudeinstallation ist sicherzustellen: max. 16A (US max. 20A).
- Das Gerät nicht im Leerlauf betreiben!
- Das Gerät ist nicht zur Benutzung von Personen bestimmt (einschließlich Kinder) mit eingeschränkten physischen, sensorischen oder geistigen Fähigkeiten oder mangelnder Erfahrung und Wissen, es sei denn,

sie arbeiten unter Aufsicht oder erhalten eine ausführliche Anleitung zur Benutzung des Gerätes von einer Person die für die Sicherheit verantwortlich ist.



Entsorgen Sie den Aktenvernichter fach- und umweltgerecht bei einer autorisierten Sammelstelle. Geben Sie keine Teile des Aktenvernichters oder der Verpackung in den Hausmüll.

1.3 Piktogrammlegende

	Wichtige Information		Das Gerät standsicher auf dem Boden und mit 100 mm Abstand zur Wand aufstellen, Stauwärme vermeiden, Feststellbremsen betätigen (Typenabhängig).		Halten Sie Spraydosen fern!
	Gebrauchsanleitung/ Sicherheitshinweise lesen.		Nicht in der Nähe von brennbaren Flüssigkeiten oder Gasen verwenden.		Büro- und Heftklammern vor dem Vernichtungsvorgang entfernen!
	ACHTUNG		Nicht in der Nähe von brennbaren Flüssigkeiten oder Gasen verwenden.		Keine Disketten einführen!
	VORSICHT, Gefahr eines elektrischen Schlags.		Automatischer Anlauf		Beim Vernichten von CD/ DVD ist eine Schutzbrille zu tragen!
	ACHTUNG, bewegende Teile Diese Einrichtung ist nicht für die Benutzung durch Kinder vorgesehen, Berührung der Einführungsöffnung mit den Händen, der Kleidung oder den Haaren vermeiden. Stecker ziehen, wenn die Einrichtung längere Zeit nicht benutzt wird.		Nicht der Nässe aussetzen		Vor Wartungsarbeiten den Aktenvernichter von der Stromversorgung trennen!
	ACHTUNG, scharfe Kanten. Nicht berühren.		Dieser Aktenvernichter ist nicht zur Benutzung durch Kinder bestimmt (das Produkt ist kein Spielzeug).		Technische Daten - Technische Änderungen vorbehalten!
	Nicht in der Nähe von ätzenden Stoffen verwenden.		Berühren Sie die Papierzuführung nicht mit den Händen.		Betriebslautstärke im Leerlauf
			Berühren Sie die Papierzuführung nicht mit Kleidungsstücken!		Einzugsgeschwindigkeit
			Berühren Sie die Papierzuführung nicht mit den Haaren!		Papier-Streifenschnitt



Papier-Partikelschnitt



CD/DVD-Streifenschnitt



CD/DVD-Partikelschnitt



Karten-Streifenschnitt



Karten-Partikelschnitt



Sicherheitsstufe - P
Papiervernichtung



Sicherheitsstufe - F
Mikrofilmvernichtung



Sicherheitsstufe - O
CD, DVD-Vernichtung



Sicherheitsstufe - T
Kartenvernichtung



Sicherheitsstufe - E
Chipkartenvernichtung



Gewicht



Netzstecker dient als Trenn-
vorrichtung der Stromver-
sorgung.



Die schutzgeerdete Netz-
steckdose muß jederzeit
leicht zugänglich sein!



Bedienung



Aktenvernichter in Bereit-
schaft



Aktenvernichter in Betrieb



Automatische Abschalt-
ung!



Bei längerem Betrieb und/
oder Überlastung schaltet
der Aktenvernichter auto-
matisch zum Abkühlen ab.



Wartungshinweise / Stö-
rungs-beseitigung



Behälter voll



Mögliche Störungen



automatische Abschaltung
bei offenem Gehäuse



Überhitzung



Motorblockade

en Instructions



IMPORTANT!

Read the operating and safety instructions BEFORE placing the document shredder into operation.



You must follow the instructions. Keep the operating instructions in a safe place ready for later use.

- CDs/DVDs, bank cards and credit cards (see technical data).
- The normal staples and paper clips found in paper documents (exception: security level P6 and P7 devices).

Wear, damage due to improper use or unauthorised modifications and repairs are not covered by the warranty or the guarantee.

Table of Contents

1	Important information	7
1.1	Intended use, warranty	7
1.2	Safety instructions	7
1.3	Key to pictograms	8
1.4	Scope of supply	88
1.5	Technical data	88
2	Operation	89
2.1	Remove transport lock	89
2.2	Connecting the device to the power supply	90
2.4	Switching on the device	90
2.5	Paper shredding	91
2.8	Continuous operation	92
2.9	CD, DVD & card shredding	93
3	Maintenance/troubleshooting	95
3.1	Empty shredded waste	95
3.3	Container/cover open	95
3.4	Overheating	96
3.6	Paper jam	96
3.7	Cleaning the device	97
3.9	Oil the device	98

The document shredder was designed for private use and for use in normal office environments.

The following conditions apply to the performance in terms of sheets listed under technical data:

Maximum number of sheets that are shredded in one pass under the following conditions: New cutting rollers, oiled if needed, cold motor, power supply with nominal voltage and nominal frequency (230V/50Hz; 120V/60Hz).

Deviations may result in reduced sheet processing and increased operating noises. The sheets are fed centrally and lengthwise at a 90 degree angle. The performance in terms of sheets can also vary depending on the paper properties and input.

1.2 Safety instructions

- Check that the voltage and mains frequency of your electricity supply match the information on the nameplate.
- Do not place the device near a source of heat.
- Store, transport and operate the device in an upright position only.
- Only use liquids and gases on the device that comply with DAHLE guidelines.
- Do not open up the device. Risk of electric shock.
- Only operate the device in closed spaces, at temperatures of between 10 °C and 25 °C (50 °F to 77 °F) and at a non-condensing humidity of between 15 % and 95 %.
- Ensure that the building installation has short-circuit protection: max. 16A(US max. 20A).
- Do not operate the document shredder without inserting documents.
- The device is not intended for use by persons (includ-

1.1 Intended use, warranty

The document shredder is intended to be used for shredding paper.

Depending on the model variant, a small amount of the following materials can also be shredded:



ing children) with restricted physical, sensory or mental capabilities or a lack of experience and knowledge, unless they are working under supervision or receive detailed instruction about how to use the device from a person who is responsible for safety.

NOTE: This equipment has been tested and found to comply with the limits for a Class B digital device, pursuant to part 15 of the FCC Rules. These limits are designed to provide reasonable protection against harmful interference in a residential installation. This equipment generates, uses and can radiate radio frequency energy and, if not installed and used in accordance with the instructions, may cause harmful interference to radio communications. However, there is no guarantee that interference will not occur in a particular installation. If this equipment does cause harmful interference to radio or television reception, which can be determined by turning the equipment off and on, the user is encouraged to try to correct the interference by one or more of the following measures:

- Reorient or relocate the receiving antenna.
- Increase the separation between the equipment and receiver.
- Connect the equipment into an outlet on a circuit different from that to which the receiver is connected.
- Consult the dealer or an experienced radio/TV technician for help.

WARNING: Changes or modifications to this unit, not expressly approved by the party responsible for compliance, could void the user's authority to operate the equipment!



Dispose of the document shredder properly in an environmentally friendly way at an authorised collection point. Do not dispose of any parts of the document shredder or packaging in domestic waste.

1.3 Key to pictograms



Important information



Do not use near caustic substances.



WARNING, moving parts
This equipment is not intended for use by children. Avoid touching the media feed opening with the hands, clothing or hair. Unplug this equipment when not in use for an extended period of time, hazardous moving parts in this equipment, keep body parts away from moving parts.



User information/safety instructions



Do not use near inflammable liquids or gases.



WARNING



Place the device in a stable position on the floor, leaving a gap of 100 mm to the wall, ensure no heat can accumulate, engage brake mechanisms (depending on type)



CAUTION! Risk of electric shock.



ATTENTION, sharp edges.
Do not touch.



Automatic start-up



Do not expose to moisture



This document shredder is not intended to be used by children (the product is not a toy).



Do not touch the paper feed with your hands.



Do not allow items of clothing to come into contact with the paper feed.



Do not allow your hair to come into contact with the paper feed.



Keep spray cans away from the device.



Remove paper clips and staples before shredding.



Do not insert any diskettes.



Always wear safety goggles when destroying CDs/DVDs!



Disconnect the document shredder from the electrical power supply before performing maintenance work.



Technical specifications - Subject to technical modifications.



Noise level when operated without shredding documents



Intake speed



Paper - strip cut



Paper - cross cut



CD/DVD strip cut



CD/DVD - cross cut



Card - strip cut



Card - cross cut



Security Level - P paper shredding



Security Level - F microfilm destruction



Security Level - O CD, DVD destruction



Security Level - T card destruction



Security Level - E chip card destruction



Weight



The power plug is used to disconnect the power supply.



The power outlet must be earthed and easily accessible at all times !



How to use



Document shredder on standby



Document shredder in operation



Automatic shut-down!



The document shredder will switch off automatically to cool down if used for a long time and /or if overloaded



Maintenance instructions / troubleshooting



Container full



Possible malfunctions



Automatic switch-off when housing is open



Overheating



Engine blockage



fr Mode d'emploi



ATTENTION !

Lisez attentivement le mode d'emploi et les consignes de sécurité AVANT de mettre en marche le destructeur de documents !



Les consignes doivent être appliquées !

Conservez le mode d'emploi pour une utilisation ultérieure.

Sommaire

1	Informations importantes	10
1.1	Utilisation conforme, garantie	10
1.2	Consignes de sécurité	10
1.3	Légende des pictogrammes	11
1.4	Contenu de la livraison	88
1.5	Caractéristiques techniques	88
2	Utilisation	89
2.1	Retirer la sécurité de transport	89
2.2	Connecter l'appareil au réseau électrique	90
2.4	Allumer l'appareil	90
2.5	Destruction de documents	91
2.8	Avance continue	92
2.9	Destruction de CD/DVD et de cartes	93
3	Entretien/dépannage	95
3.1	Vider le matériau découpé	95
3.3	Bac/couvercle ouvert	95
3.4	Surchauffe	96
3.6	Bourrage papier	96
3.7	Nettoyer l'appareil	97
3.9	Huiler l'appareil	98

1.1 Utilisation conforme, garantie

Le destructeur de documents est destiné à détruire des documents papier. Selon le modèle, vous pouvez en outre utiliser l'appareil pour détruire les matériaux suivants en petite quantité:

- CD/DVD, cartes bancaires et de crédit (voir Caractéristiques techniques).
- Les agrafes et trombones présents dans les documents en papier, en quantités représentant une utilisation normale (exception : appareils de niveau de sécurité P6 et P7).

Le destructeur de documents est conçu pour l'utilisation domestique et en environnement de bureau normal.

En ce qui concerne la capacité de feuilles mentionnée dans les caractéristiques techniques, les conditions cadres suivantes sont applicables:

Nombre maximum de feuilles pouvant être découpées en un passage dans les conditions suivantes: Rouleaux de coupe neufs, huilés le cas échéant, moteur froid, alimentation avec tension et fréquence nominales (230V/50 Hz ; 120V/60 Hz).

Des divergences peuvent entraîner une capacité de feuilles réduite et des émissions sonores accrues. Les feuilles sont introduites au centre et en longueur à un angle inférieur à 90°. La capacité de feuilles peut également varier selon les caractéristiques du papier et l'introduction.

1.2 Consignes de sécurité

- Vérifiez que la tension et la fréquence de votre réseau électrique correspondent aux indications figurant sur la plaque signalétique.
- Ne pas installer l'appareil à proximité d'une source de chaleur !
- Ranger, transporter ou utiliser l'appareil en position verticale uniquement !
- Utiliser à proximité de l'appareil uniquement des liquides et des gaz conformes aux directives DAHLE !
- Il est interdit d'ouvrir l'appareil ! Risque de choc électrique !
- Utiliser l'appareil dans des locaux fermés uniquement,

à des températures comprises entre 10°C et 25°C (entre 50°F et 77°F) et une hygrométrie non condensée comprise entre 15% et 95% !

- L'installation électrique du bâtiment doit être protégée contre les courts-circuits 16Amax. (20Amax. aux USA).
- Ne pas laisser l'appareil tourner à vide !
- L'appareil n'est pas destiné à une utilisation par des personnes (y compris les enfants) aux capacités physiques, sensorielles ou mentales diminuées ou ne disposant pas de l'expérience et du savoir nécessaire,

à moins que celles-ci soient sous surveillance ou qu'elles reçoivent des consignes exhaustives concernant l'utilisation de l'appareil de la part d'une personne responsable de la sécurité.



Éliminez le destructeur de documents dans le respect des règles et de l'environnement dans un point de collecte autorisé. Ne jetez pas de composants du destructeur de documents ou de l'emballage dans les ordures ménagères.

1.3 Légende des pictogrammes



Information importante



Lire les informations pour l'utilisateur/consignes de sécurité



ATTENTION



ATTENTION! Risque de choc électrique.



ATTENTION, pièces mobiles



ATTENTION, arêtes vives



Ne pas utiliser l'appareil à proximité de substances corrosives.



Placer l'appareil au sol de manière à ce qu'il soit bien stable et à une distance de 100 mm du mur, éviter la chaleur stagnante, actionner les freins de blocage (selon le modèle)



Ne pas utiliser l'appareil à proximité de liquides ou de gaz inflammables.



Démarrage automatique



Ne pas exposer l'appareil à l'humidité.



Ce destructeur de documents n'est pas destiné à être utilisé par des enfants (le produit n'est pas un jouet).



Ne touchez pas le dispositif d'alimentation du papier avec les mains.



Ne touchez pas le dispositif d'alimentation du papier avec vos vêtements !



Ne touchez pas le dispositif d'alimentation du papier avec vos cheveux !



Tenez les bombes aérosols à l'écart !



Retirer les trombones et les agrafes des documents avant de les détruire !



Ne pas introduire de disquettes !



Lors de la destruction de CD/DVD, le port de lunettes de protection est obligatoire !



Débrancher le destructeur de documents de l'alimentation électrique avant de procéder aux opérations d'entretien !



Caractéristiques techniques - Sous réserve de modifications techniques !



Volume sonore à vide



Vitesse d'introduction



Papier - coupe en bande-
lettes (fibres)



Papier - coupe croisée (par-
ticules)



CD/DVD - coupe en bande-
lettes (fibres)



CD/DVD - coupe croisée
(particules)



Cartes - coupe en bande-
lettes (fibres)



Cartes - coupe croisée (par-
ticules)



Niveau de sécurité - P
Destruction de papier



Niveau de sécurité - F
Destruction de microfilms



Niveau de sécurité - O
Destruction de CD, DVD



Niveau de sécurité - T
Destruction de carte



Niveau de sécurité - E
Destruction de carte à puce



Poids



La prise sert de dispositif
de sectionnement de l'alimen-
tation électrique.



La prise de courant raccor-
dée à la terre doit toujours
être aisément accessible !



Utilisation



Destructeur de documents
en veille



Destructeur de documents
en marche



Arrêt automatique !



Le destructeur de docu-
ments s'éteint automa-
tiquement après une
utilisation prolongée et/ou
en cas de surcharge afin de
refroidir.



Consignes d'entretien/
Dépannage



Bac plein



Problèmes possibles



Arrêt automatique en cas
de boîtier ouvert



Surchauffe



Blocage du moteur

es Instrucciones



ATENCIÓN:

Lea detenidamente las instrucciones de uso y las indicaciones sobre seguridad antes de poner en marcha la destructora.



Deben cumplirse todas las indicaciones. Guarde el manual de instrucciones por si lo necesita en otro momento.

1.1 Utilización conforme al uso prescrito, garantía

La destructora está destinada a triturar papel. Según la variante del modelo, se puede triturar además una pequeña cantidad de los siguientes materiales:

- CDs/DVDs, tarjetas bancarias y tarjetas de crédito (véase Datos técnicos).
- Los clips y grapas que lleven los documentos en papel, dentro de los límites del uso habitual (excepción: equipos de nivel de seguridad P6 y P7).

Índice

1	Información importante.....	13
1.1	Utilización conforme al uso prescrito, garantía. .	13
1.2	Indicaciones de seguridad.....	13
1.3	Significado de los pictogramas.....	14
1.4	Contenido de suministro.....	88
1.5	Datos técnicos.....	88
2	Manejo.....	89
2.1	Retirar el bloqueo de transporte.....	89
2.2	Conectar el aparato a la red eléctrica.....	90
2.4	Encender el aparato.....	90
2.5	Destrucción de papel.....	91
2.8	Ejecución continua.....	92
2.9	Destrucción de CD/DVD y tarjetas.....	93
3	Mantenimiento/Resolución de problemas.....	95
3.1	Vaciado del contenedor.....	95
3.3	Contenedor abierto.....	95
3.4	Sobrecalentado.....	96
3.6	Atasco de papel.....	96
3.7	Limpieza del aparato.....	97
3.9	Aceite el aparato.....	98

La garantía no cubre el desgaste, los daños causados por uso indebido ni las consecuencias de una manipulación por parte de terceros.

La destructora está pensada para su uso por particulares y en entornos normales de oficina.

Los datos técnicos relativos a la alimentación de papel están sujetos a las siguientes condiciones:
 Cantidad máxima de hojas cortadas de una vez en las siguientes condiciones: Tambor de corte nuevo y engrasado (si procede), motor en frío, corriente eléctrica con tensión y frecuencia nominal (230V/50Hz; 120V/60Hz).

Las variaciones pueden repercutir en una reducción de la alimentación de papel y en un aumento de los ruidos de funcionamiento. Las hojas se deben introducir centradas y a lo largo a 90°. La capacidad de alimentación del papel también puede variar dependiendo de las características del papel y el modo de introducirlo.

1.2 Indicaciones de seguridad

- Compruebe que la tensión y la frecuencia de red de su red eléctrica coincide con las indicaciones de la placa de características.
- No colocar el aparato cerca de ninguna fuente de calor.
- Almacenar, transportar y utilizar el aparato exclusivamente en posición vertical.
- Aplicar a la destructora exclusivamente líquidos y gases que cumplan las especificaciones de DAHLE.
- No abrir el aparato! Riesgo de shock eléctrico!
- Utilizar el aparato exclusivamente en lugares cerrados,

a una temperatura entre 10°C y 25°C (entre 50°F y 77°F) y con una humedad ambiental no condensante entre el 15% y el 95%.

- La instalación eléctrica del edificio deberá estar protegida contra cortocircuitos: máx. 16A(para EE.UU. máx. 20A).
- El aparato nunca debe funcionar en vacío.
- Este aparato no está destinado a su uso por parte de personas (incluidos niños) con facultades físicas, sensoriales o mentales reducidas o con falta de expe-

riencia y conocimiento, salvo que lo utilicen bajo la supervisión de una persona que se responsabilice de la seguridad o esta les haya instruido de forma detallada en el manejo del aparato.





Desechar la destructora debidamente en un punto limpio autorizado y cumpliendo la normativa medioambiental. No deseche ninguna parte de la destructora ni del embalaje con la basura doméstica.

1.3 Significado de los pictogramas

	Información importante		No utilizar cerca de líquidos o gases inflamables.		No introducir disquetes.
	Leer atentamente la información para el usuario y las indicaciones de seguridad		Inicio automático		Cuando se destruyan CD o DVD, deben colocarse gafas protectoras.
	ATENCIÓN		Evitar que el aparato se moje.		Antes de realizar cualquier trabajo de mantenimiento, desconectar la destructora de la red eléctrica.
	Precaución! Riesgo de shock eléctrico.		Esta destructora no está destinada para ser utilizada por niños (este producto no es un juguete).		Datos técnicos - ¡Sujeto a modificaciones técnicas sin previo aviso!
	ATENCIÓN, partes móviles		No tocar el alimentador de papel.		Emisión de ruido durante el funcionamiento
	ATENCIÓN, bordes afilados		Evitar que la ropa entre en contacto con el alimentador de papel.		Velocidad de inserción
	No utilizar cerca de sustancias corrosivas.		No aproximar el cabello al alimentador de papel.		Papel - corte en tiras
	Colocar el aparato en el suelo y en posición vertical estable, a una distancia de 100 mm de la pared, evitando que se acumule el calor, accionar los frenos inmovilizadores (en determinados modelos)		No aproximar botes de espray.		Papel - corte en partículas
			Antes de destruir papel, retirar todos los clips y grapas que pueda llevar.		CD/DVD - corte en tiras

 CD/DVD - Corte en partículas

 Tarjetas - corte en tiras

 Tarjetas - corte en partículas

 Nivel de seguridad - P
Destrucción de papel

 Nivel de seguridad - F
Destrucción de microfilmes

 Nivel de seguridad - O
Destrucción de CD, DVD

 Nivel de seguridad - T
Destrucción de la tarjeta

 Nivel de seguridad - E
Destrucción de tarjetas con chip

 Peso

 La clavija de red actúa como dispositivo desconectador de la alimentación eléctrica.

 El enchufe debe estar fácilmente accesible en todo momento.

 Manejo

 Destruidora lista para ser utilizada

 Destruidora en funcionamiento

 Desconexión automática.

 En caso de sobrecarga o de un uso excesivo, la destructora se apaga automáticamente para enfriarse.

 Consejos de mantenimiento y resolución de problemas

 Depósito lleno

 Posibles averías

 El aparato se desconecta automáticamente cuando se abre la carcasa.

 Sobrecalentado

 Bloqueo del motor



it Istruzioni per l'uso



ATTENZIONE!

PRIMA della messa in funzione della distruggidocumenti, leggere attentamente il manuale d'uso e le istruzioni di sicurezza.



Le istruzioni devono essere applicate!
Conservare il manuale d'uso per l'utilizzo successivo.

Indice

1	Informazioni importanti.....	16
1.1	Utilizzo conforme, garanzia.....	16
1.2	Istruzioni di sicurezza.....	16
1.3	Legenda pittogrammi.....	17
1.4	Oggetto della fornitura.....	88
1.5	Dati tecnici.....	88
2	Uso.....	89
2.1	Rimozione del blocco di trasporto.....	89
2.2	Collegare l'apparecchio alla rete della linea elettrica.....	90
2.4	Accendere l'apparecchio.....	90
2.5	Distruzione della carta.....	91
2.8	Avanzamento permanente.....	92
2.9	Distruzione di CD/DVD e carte.....	93
3	Manutenzione/Riparazione.....	95
3.1	Eliminare il materiale triturato.....	95
3.3	Contenitore/coperchio aperto.....	95
3.4	Surriscaldamento.....	96
3.6	Carta inceppata.....	96
3.7	Pulizia dell'apparecchio.....	97
3.9	Oliare dell'apparecchio.....	98

1.1 Utilizzo conforme, garanzia

Il distruggi documenti è destinato alla distruzione di carta.

A seconda del modello è inoltre possibile distruggere una piccola quantità dei seguenti materiali:

- CD/DVD, carte assegni e carte di credito (vedere dati tecnici).
- Le graffette e i punti metallici comunemente utilizzati per fascicolare i documenti di carta (eccezione: apparecchi di livello di sicurezza P6 e P7).

La garanzia non comprende l'usura, i danni da utilizzo non conforme nonché gli interventi da parte di terzi.

Il distruggi documenti è concepito per l'utilizzo privato o per il normale utilizzo d'ufficio.

La portata di fogli riportata nei dati tecnici è soggetta alle seguenti condizioni generali:

Numero massimo di fogli tagliati per volta nelle seguenti condizioni: rulli da taglio nuovi o lubrificati, motore freddo, alimentazione con tensione nominale e frequenza nominale (230V/50 Hz; 120V/60 Hz). Condizioni diverse da quelle indicate possono comportare una portata di fogli inferiore e un aumento del rumore generato dal dispositivo in funzione. I fogli vanno inseriti al centro e per il lungo con un'inclinazione inferiore a 90°. La portata di fogli può variare a seconda delle proprietà della carta e dell'inserimento.

1.2 Istruzioni di sicurezza

- Verificare che la tensione e la frequenza di rete siano conformi ai dati riportati sulla targhetta identificativa.
- Non posizionare l'apparecchio in prossimità di fonti di calore!
- Utilizzare, riporre e trasportare l'apparecchio esclusivamente in posizione verticale!
- Sull'apparecchio utilizzare solo sostanze liquide o gassose conformi alle direttive DAHLE!
- Non aprire l'apparecchio! Rischio di scossa elettrica!
- È necessario garantire che l'impianto dell'edificio sia protetto da cortocircuiti: max. 16A (US massimo 20A).
- Utilizzare l'apparecchio solo in ambienti chiusi, a

temperature comprese tra i 10°C e i 25°C (da 50°F a 77°F) e con un'umidità dell'aria senza condensa tra il 15% e il 95%!

- Non utilizzare l'apparecchio a vuoto!
- L'apparecchio non è adatto all'utilizzo da parte di persone con ridotte capacità fisiche, sensoriali o mentali (inclusi i bambini), oppure prive della necessaria esperienza o conoscenza, a meno che non lavorino sotto sorveglianza o che ricevano istruzioni dettagliate circa l'utilizzo dell'apparecchio da una persona responsabile della sicurezza.



La distruggidocumenti deve essere smaltita in conformità con le norme vigenti in materia di tutela dell'ambiente presso un centro di raccolta autorizzato. Non gettare alcun componente della distruggidocumenti o dell'imballaggio nei rifiuti domestici.

1.3 Leggenda pittogramma

	Informazioni importanti		Non utilizzare in prossimità di liquidi o gas infiammabili.		Non inserire dischetti!
	Leggere le informazioni utente e le istruzioni di sicurezza		Avvio automatico		Indossare occhiali di protezione, quando si distruggono CD/DVD.
	ATTENZIONE		Non esporre all'umidità		Prima degli interventi di manutenzione, staccare la presa della distruggidocumenti!
	ATTENZIONE! Rischio di scossa elettrica.		L'apparecchio non è destinato all'uso da parte dei bambini (il prodotto non è un giocattolo).		Dati tecnici – Si riserva la facoltà di apportare modifiche tecniche!
	ATTENZIONE, parti in movimento		Non toccare l'alimentatore della carta con le mani.		Rumorosità in esercizio a vuoto
	ATTENZIONE, spigoli vivi		Assicurarsi che gli abiti non tocchino l'alimentatore della carta!		Velocità di inserimento
	Non utilizzare in prossimità di sostanze corrosive.		Non toccare l'alimentatore della carta con i capelli!		Taglio carta a strisce
	Posizionare l'apparecchio sul pavimento e a una distanza di 100 mm dalla parete, evitare ristagni di calore, azionare i freni di blocco (a seconda del modello)		Tenere lontano da bombolette spray!		Taglio carta a particelle
			Prima di distruggere i documenti, rimuovere punti e graffette!		Taglio CD/DVD a strisce



Taglio CD/DVD a particelle



Taglio carte plastificate a strisce



Taglio carte plastificate a particelle



Livello di sicurezza - P
Distruzione della carta



Livello di sicurezza - F
Distruzione di microfilm



Livello di sicurezza - O
Distruzione di CD, DVD



Livello di sicurezza - T
Distruzione delle carte



Livello di sicurezza - E
Distruzione della chip card



Peso



La spina funge da separatore dell'alimentazione di corrente.



La presa di rete con messa a terra deve essere sempre facilmente accessibile!



Utilizzo



Distruggidocumenti in standby



Distruggidocumenti in esercizio



Spegnimento automatico!



Dopo un periodo di esercizio prolungato e/o sovraccarico la distruggidocumenti si spegne automaticamente per garantire il raffreddamento.



Istruzioni per la manutenzione/Risoluzione delle anomalie



Recipiente pieno



Possibili guasti/anomalie



Spegnimento automatico in caso di cassetto aperto



Surriscaldamento



Blocco del motore

pt Manual de instruções



ATENÇÃO!

ANTES de colocar a trituradora de papel funcionamento, ler cuidadosamente o manual de utilização e as indicações de segurança.



As indicações devem ser respeitadas!
 Guarde o manual de utilização para uso futuro.

Índice

1	Informações importantes.....	19
1.1	Utilização correta, garantia.....	19
1.2	Indicações de segurança.....	20
1.3	Legenda dos pictogramas.....	20
1.4	Âmbito de fornecimento.....	88
1.5	Dados técnicos.....	88
2	Operação.....	89
2.1	Remoção da fechadura de transporte.....	89
2.2	Ligar o aparelho à rede elétrica.....	90
2.4	Ligar o aparelho.....	90
2.5	Trituração de papel.....	91
2.8	Pré-funcionamento permanente.....	92
2.9	Trituração de CDs/DVDs e cartões.....	93
3	Manutenção/resolução de problemas.....	95
3.1	Esvaziar os resíduos de papel.....	95
3.3	Recipiente aberto.....	95
3.4	Sobreaquecimento.....	96
3.6	Atolamento de papel.....	96
3.7	Limpar o aparelho.....	97
3.9	Olear o aparelho.....	98

1.1 Utilização correta, garantia

A trituradora de papel destina-se à trituração de papel. Conforme a variante do modelo podem ser eliminados os seguintes materiais em quantidades reduzidas:

- CDs/DVDs, cartões de crédito e de cheque (ver dados técnicos).
- Clipes e agrafos que estejam presentes, em quantidades normais, nos documentos de papel (exceção: aparelhos com nível de segurança P6 e P7).

Desgaste, danos provocados por uma utilização incorreta, assim como intervenções de terceiros não estão abrangidos pela garantia, nem o fabricante assume qualquer responsabilidade pelos mesmos.

A trituradora de papel foi concebida para uso doméstico e para o funcionamento num ambiente de escritório normal.

No que se refere ao desempenho das folhas indicado nos dados técnicos, aplicam-se as seguintes condições básicas:

Número máximo de folhas cortadas de uma só vez, segundo as seguintes condições de funcionamento: Rolamentos de corte novos ou possivelmente oleados, motor frio, fonte de alimentação com tensão nominal e frequência nominal (230V/50Hz; 120V/60Hz). O não cumprimento destas condições de funcionamento pode levar ao desempenho reduzido da lâmina e ao aumento de ruídos de funcionamento. As folhas devem ser introduzidas centralmente e longitudinalmente a 90°. As propriedades do papel e da sua forma de introdução também podem alterar o desempenho das folhas.





















1.2 Indicações de segurança

- Verificar se a tensão e a frequência de rede da sua rede de corrente correspondem às indicações da placa de identificação.
 - Não colocar o aparelho perto de uma fonte de calor!
 - Armazenar, transportar ou utilizar o aparelho exclusivamente na vertical!
 - Utilizar no aparelho apenas líquidos e gases que correspondam às diretivas DAHLE!
 - Não abrir o aparelho!
 - O aparelho deve ser operado exclusivamente em espaços fechados, a uma temperatura entre os 10 °C e os 25 °C (50 °F e 77 °F) e uma humidade atmosférica não condensada de 15% a 95%!
 - Providenciar a proteção contra curto-circuito na instalação dos edifícios: máx. 16A(EUA: máx. 20A).
 - Não utilizar o aparelho em vazio!
- Este aparelho não é indicado para utilização por pessoas (incluindo crianças) com capacidades físicas, sensoriais ou mentais reduzidas ou com pouca experiência e conhecimento, exceto se forem supervisionadas durante o trabalho ou receberem instruções relativamente à utilização do aparelho por uma pessoa responsável pela sua segurança.



Elimine a trituradora de papel de forma adequada e compatível com o meio ambiente num ponto de recolha autorizado. Não coloque nenhuma peça da trituradora de papel ou a embalagem no lixo doméstico.

1.3 Legenda dos pictogramas

- | | | | | | |
|--|--|---|--|---|--|
|  | Informações importantes |  | Pousar o aparelho de forma estável no chão e com uma distância de 100 mm da parede. Evitar a acumulação de calor. Acionar os travões de fixação (consoante o modelo) |  | Não toque com a roupa na alimentação do papel! |
|  | Ler as informações ao utilizador/indicações de segurança |  | Não utilizar junto de líquidos ou gases inflamáveis. |  | Não toque com os cabelos na alimentação do papel! |
|  | ATENÇÃO |  | ATENÇÃO! Risco de choque elétrico. |  | Mantenha latas de aerossol afastadas do dispositivo! |
|  | ATENÇÃO, peças móveis |  | Iniciação automática |  | Remover agrafos e cliques antes do processo de trituração! |
|  | ATENÇÃO, arestas vivas |  | Não expor à humidade. |  | Não inserir disquetes! |
|  | Não utilizar junto de materiais ácidos. |  | Esta trituradora de papel não se destina a ser utilizada por crianças (o produto não é nenhum brinquedo). |  | Ao destruir CDs/DVDs, usar óculos de proteção! |
| | |  | Não toque com as mãos na alimentação do papel. |  | Antes dos trabalhos de manutenção, desligar a trituradora de papel da rede elétrica! |

- | | | | | | |
|--|---|--|---|--|---|
| | Dados técnicos – Sujeito a alterações técnicas! | | Nível de segurança - F
Destruição de microfilme | | Desativação automática! |
| | Volume de funcionamento em vazio | | Nível de segurança - O
Destruição de CD, DVD | | Após um funcionamento prolongado e/ou sobrecarga, a trituradora de papel desliga-se automaticamente para arrefecer. |
| | Velocidade de recolhi-mento | | Nível de segurança - T
Destruição de cartas | | Indicações de manutenção/
eliminação de avarias |
| | Papel - corte em tiras | | Nível de segurança - E
Destruição de chip | | Recipiente cheio |
| | Papel - corte em partículas | | Peso | | Possíveis avarias |
| | CD/DVD - corte em tiras | | A ficha serve de dispositivo separador da alimentação de energia. | | Desativação automática no caso de abertura da caixa |
| | CDs/DVDs - corte em par-tículas | | A tomada de rede com ligação à terra deve estar sempre acessível! | | Sobreaquecimento |
| | Cartão - corte em tiras | | Operação | | Bloqueio do motor |
| | Cartão - corte em parti-culas | | Trituradora de papel ope-racional | | |
| | Nível de segurança - P
Trituração de papel | | Trituradora de papel em funcionamento | | |



nl Gebruikershandleiding



OPGELET!

VOOR u de papiervernietiger gebruikt, moet u aandachtig de handleiding en veiligheidsaanwijzingen lezen!



Volg alle veiligheidsvoorschriften!
Bewaar de handleiding voor later gebruik.

Inhoudsopgave

1	Belangrijke informatie.....	22
1.1	Bedoeld gebruik, garantieaanspraak.....	22
1.2	Veiligheidsaanwijzingen.....	22
1.3	Legenda van pictogrammen.....	23
1.4	Leveringsomvang.....	88
1.5	Technische gegevens.....	88
2	Bediening.....	89
2.1	Verwijderen van de transportvergrendeling.....	89
2.2	Apparaat op het stroomnet aansluiten.....	90
2.4	Apparaat inschakelen.....	90
2.5	Papiervernietiging.....	91
2.8	Constante loopmodus.....	92
2.9	CD/DVD-, kaartvernietiging.....	93
3	Onderhoud/probleemoplossing.....	95
3.1	Versnipperd materiaal verwijderen.....	95
3.3	Opvangbak open.....	95
3.4	Oververhitting.....	96
3.6	Papierverstopping.....	96
3.7	Apparaat reinigen.....	97
3.9	Olie het apparaat.....	98

1.1 Bedoeld gebruik, garantieaanspraak

De papiervernietiger is bedoeld voor het versnipperen van papier. Afhankelijk van de modelvariant kunnen naast papier ook kleine hoeveelheden van de volgende materialen worden vernietigd:

- cd's/dvd's, betaalpasjes en creditcards (zie Technische gegevens).
- In papieren documenten aanwezige nietjes en paperclips (uitzondering: apparaten met veiligheidsniveau P6 en P7).

Slijtage of schade door onjuist gebruik vallen net als ingrepen van derden noch onder de garantieaanspraak, noch onder de garantie.

De papiervernietiger is ontworpen voor privé gebruik en normaal gebruik in een kantooromgeving.

De volgende voorwaarden zijn van toepassing op de prestaties van het vel gespecificeerd onder technische gegevens:

Maximumaantal vellen in één keer gesneden onder de volgende omstandigheden: Nieuwe of geoliede snijrollen, koude motor, voeding met nominale spanning en nominale frequentie (230V/50 Hz, 120V/60Hz). Afwijkingen kunnen leiden tot lagere prestaties en meer geluid. De vellen worden in het midden en in de lengte onder 90° ingevoerd. Afhankelijk van de papiereigenschappen en invoer, kan de veluitvoer ook variëren.

1.2 Veiligheidsaanwijzingen

- Controleer of de spanning en stroomfrequentie van uw stroomnetwerk overeenkomen met de gegevens op het typeplaatje.
- Het apparaat niet in de nabijheid van warmtebronnen opstellen!
- Het apparaat uitsluitend rechtop staand bewaren, transporteren en gebruiken!
- Gebruik voor het apparaat uitsluitend vloeistoffen en gassen die aan de DAHLE-richtlijnen voldoen!
- Het apparaat mag niet worden geopend!
- Het apparaat alleen gebruiken in gesloten ruimtes met een omgevingstemperatuur van 10 °C tot 25 °C

(50°F tot 77°F) en een niet-condenserende luchtvochtigheid van 15% tot 95%!

- Er moet een kortsluitingszekering in de elektrische installatie van het gebouw aanwezig zijn van max. 16A (VS 20A).
- Het apparaat niet leeg gebruiken!
- Het apparaat is niet bedoeld voor gebruik door personen (inclusief kinderen) met verminderde lichamelijke, zintuiglijke of verstandelijke vermogens of gebrek aan ervaring en kennis, tenzij ze werken onder toezicht of



instructies krijgen over het gebruik van het apparaat door een persoon die verantwoordelijk is voor de veiligheid.



Lever voor een milieuvriendelijke en vakkundige afvalverwerking de papiervernietiger in bij een bevoegd verwerkingsbedrijf. Zet geen delen van de papiervernietiger of het verpakkingsmateriaal bij het huisvuil.

1.3 Legende van pictogrammen

	Belangrijke informatie		Niet gebruiken in de nabijheid van ontvlambare vloeistoffen of gasen.		Voor men papier versnipert, moet men paperclips en nietjes verwijderen!
	Gebruikersinformatie/veiligheidsaanwijzingen lezen		Automatische start		Geen diskettes invoeren!
	Waarschuwing		Niet aan vochtigheid blootstellen.		Draag een veiligheidsbril bij het vernietigen van een cd/dvd!
	AANDACHT! Risico op elektrische schokken.		Deze papiervernietiger is niet bedoeld voor gebruik door kinderen (dit product is geen speelgoed).		Alvorens onderhoudswerkzaamheden aan de papiervernietiger uit te voeren, moet men de stekker uit het stopcontact halen!
	VOORZICHTIG, bewegende onderdelen		Raak de papierinvoeropening niet aan met uw handen.		Technische gegevens - technische wijzigingen onder voorbehoud!
	VOORZICHTIG, scherpe randen		Houd kledingstukken uit de buurt van de papierinvoeropening!		Werkingsgeluidsterkte bij onbelast gebruik
	Niet gebruiken in de nabijheid van agressieve stoffen.		Blijf met uw haar uit de nabijheid van de papierinvoeropening!		Doorvoersnelheid
	Zet het apparaat op een stabiele ondergrond op minstens 10 cm van de muur. Voorkom warmteaccumulatie. Vastzetremmen gebruiken (modelafhankelijk)		Houd spuitbussen uit de buurt van de papiervernietiger!		Papier - strokensnit

	Papier - deeltjessnit		Beveiligings niveau - E Chipkaart vernietiging		Bij langdurig gebruik en/ of overbelasting wordt de papiervernietiger voor afkoeling automatisch uit- geschakeld.
	CD/DVD - strokensnit		Gewicht		Onderhoudsaanwijzingen/ storingen verhelpen
	CD/DVD - deeltjessnit		De stroomstekker dient als ontkoppelinrichting van de stroomvoorziening.		Opvangbak vol
	Kaarten - strokensnit		Het gearde stopcontact moet op elk moment gemakkelijk toegankelijk zijn!		Mogelijke storingen
	Kaarten - deeltjessnit		Bediening		Automatische uitschake- ling bij open behuizing
	Beveiligings niveau - P Papier versnipperen		Papiervernietiger gereed		Oververhitting
	Beveiligings niveau - F Vernietiging van microfilm		Papiervernietiger in bedrijf		Motorblokkering
	Beveiligings niveau - O CD, DVD vernietiging		Automatische uitschake- ling!		
	Beveiligings niveau - T Kaart vernietiging				

da Betjeningsvejledning



GIV AGT!

Læs betjeningsvejledningen og sikkerhedsanvisningerne til makulatoren nøje, FØR den tages i brug.



Anvisningerne skal følges!

Opbevar betjeningsvejledningen til senere anvendelse.

Indholdsfortegnelse

1	Vigtige oplysninger.....	25
1.1	Tilsluttet anvendelse, garanti.....	25
1.2	Sikkerhedsanvisninger.....	25
1.3	Forklaring af symboler.....	26
1.4	Pakkens indhold.....	88
1.5	Tekniske data.....	88
2	Betjening.....	89
2.1	Fjernelse af transportlåsen.....	89
2.2	Tilslutning til strømforsyningsnettet.....	90
2.4	Tænde apparatet.....	90
2.5	Papirmakulering.....	91
2.8	Kontinuerlig drift.....	92
2.9	CD-, DVD- og kortmakulering.....	93
3	Vedligeholdelse/fejlfhjælpning.....	95
3.1	Tømning.....	95
3.3	Beholder åben.....	95
3.4	Overophedning.....	96
3.6	Papirblokering.....	96
3.7	Renholdelse.....	97
3.9	Oliere skæreenheden.....	98

1.1 Tilsluttet anvendelse, garanti

Makulatoren er beregnet til makulering af papir.

Alt efter model og variant kan der desuden makuleres små mængder af følgende materialer:

- cd'er/dvd'er, check- og kreditkort (se tekniske data).
- hæfteklammer og papirclips i papirdokumenter, i normalt omfang (undtagelse: apparater på sikkerhedsniveau P6 og P7).

Slid, beskadigelse på grund af forkert anvendelse samt indgreb udført af tredjepart er hverken omfattet af garantien eller producentens hæftelse.

Makulatoren er beregnet til privat brug og i et normalt kontormiljø.

Følgende rammebetingelser er gældende for det maksimale antal ark, der er angivet i de tekniske data:

Maksimalt antal ark, der kan makuleres på én gang under følgende betingelser: Nye eller smurte skærevaller, kold motor, strømforsyning med mærkespænding og mærkefrekvens (230V/50 Hz; 120V/60 Hz). Afvigelser kan medføre, at der kan makuleres et mindre antal ark og et forhøjet støjniveau under makuleringen. Arkene tilføres midt i spalten og på langs under 90°. Antallet af ark, der kan makuleres, kan også variere, alt efter papirets egenskaber og tilføringen.

1.2 Sikkerhedsanvisninger

- Kontrollér, at netspændingen og netfrekvensen i strømnettet stemmer overens med oplysningerne på typeskiltet.
- Apparatet må ikke opstilles i nærheden af en varmekilde!
- Apparatet må kun opbevares, transporteres og anvendes opretstående!
- Brug kun væsker og gasser ved apparatet som opfylder retningslinjerne fra DAHLE.
- Apparatet må ikke åbnes!
- Apparatet må kun benyttes i lukkede rum ved 10–25 °C (50–77 °F) og ved en ikke-kondenserende luftfugtighed på mellem 15 % og 95 %!
- Tjek at strømforsyningen er sikret på bygningssiden: maks. 16A(US maks. 20A).























- Lad ikke apparatet køre i tomgang!
- Apparatet er ikke bestemt til brug af personer (herunder børn) med nedsatte fysiske evner, sansefunktioner eller mentale færdigheder eller manglende erfaring og viden, med mindre de arbejder under opsyn eller får udførlig vejledning i brugen af apparatet af en sikkerhedsansvarlig person.



Makulatoren skal bortskaffes på fagligt og miljømæssigt forsvarlig vis på en autoriseret genbrugsplads. Ingen del af makulatoren eller indpakningen må bortskaffes sammen med husholdningsaffald.

1.3 Forklaring af symboler

	Vigtige oplysninger		Må ikke anvendes i nærheden af brandbare væsker og gasser.		Sæt ikke disketter i!
	Læs brugeroplysninger/sikkerhedsanvisninger		Automatisk start		Ved destruktion af cd'er/dvd'er skal der bæres beskyttelsesbrille
	GIV AGT!		Må ikke udsættes for fugt.		Før der foretages vedligeholdelse af makulatoren, skal der slukkes for strømtilførslen!
	OPMÆRKSOMHED! Risiko for elektrisk stød.		Denne makulator er ikke beregnet til at blive brugt af børn (produktet er ikke legetøj).		Tekniske data - Forbeholdt tekniske ændringer!
	GIV AGT, bevægelige dele		Rør ikke ved papirtilførslen med hænderne.		Lydniveau i tomgang
	GIV AGT, skarpe kanter		Rør ikke ved papirtilførslen med beklædningsgenstande!		Indtrækshastighed
	Må ikke anvendes i nærheden af ætsende stoffer.		Rør ikke ved papirtilførslen med håret!		Papir-strimmelsnit
	Makulatoren skal opstilles, så den står sikkert på gulvet, og i en afstand på 100 mm fra væggen, så varmen kan slippe væk. Aktiver fastgøringsbremserne (afhænger af typen)		Hold spraydåser fjernt fra apparatet!		Papir-partikelsnit
			Fjern klips og hæfteklammer før makulering!		CD/DVD - strokensnit

- | | | | | | |
|--|--|---|--|---|---|
|  | Cd/dvd-partikelsnit |  | Vægt |  | Makulatoren slukker automatisk efter længere tids drift og/eller overbelastning for at køle af. |
|  | Kort-strimmelsnit |  | Stik tjener som skilleanordning i strømforsyningen. |  | Vedligeholdelsesanvisninger/afhjælpning af fejl |
|  | Kort-partikelsnit |  | Stikkontakten til lysnettet med jordforbindelse skal altid være let tilgængelig! |  | Opsamlingsbeholderen er fuld |
|  | Sikkerhedsniveau - P
Makulering af papir |  | Betjening |  | Mulige fejl |
|  | Sikkerhedsniveau - F
ødelæggelse af mikrofilm |  | Makulator i stand-by |  | Automatisk slukning ved åbent kabinet |
|  | Sikkerhedsniveau - O
Destruktion af CD, DVD |  | Makulator i drift |  | Overophedning |
|  | Sikkerhedsniveau - T
ødelæggelse af kort |  | Automatisk slukning! |  | Motorblokering |
|  | Sikkerhedsniveau - E
ødelæggelse af chipkort | | | | |



fi Käyttöohje



HUOMIO!

Lue käyttö- ja turvallisuusohjeet huolellisesti ENNEN asiakirjasilppurin käyttöönottoa! Ohjeita on noudatettava!



Säilytä käyttöohje myöhempiä käyttöä varten.

Sisällys

1	Tärkeitä tietoja	28
1.1	Tarkoituksenmukainen käyttö, tuotevastuu	28
1.2	Turvallisuusohjeet	28
1.3	Merkkien selitykset	29
1.4	Toimitussisältö	88
1.5	Tekniset tiedot	88
2	Käyttö	89
2.1	Kuljetuslukon poistaminen	89
2.2	Laitteen liittäminen verkkovirtaan	90
2.4	Laitteen kytkeminen päälle	90
2.5	Paperin silppuaminen	91
2.8	Kestokäyttö	92
2.9	CD/DVD-levyjen, korttien silppuaminen	93
3	Huolto/häiriönpoisto	95
3.1	Leikkuujätteen tyhjentäminen	95
3.3	Säiliö auki	95
3.4	Ylikuumeneminen	96
3.6	Paperitukoksen	96
3.7	Laitteen puhdistaminen	97
3.9	Öljyä laite	98

1.1 Tarkoituksenmukainen käyttö, tuotevastuu

Asiakirjasilppuri on tarkoitettu paperin silppuamiseen. Mallista riippuen voidaan myös tuhota pieniä määriä seuraavia materiaaleja:

- CD-/DVD-levyt ja maksukortit (katso ”Tekniset tiedot”).
- paperiasiakirjoissa, käytössä tavanomaisena määränä, olemassa olevat niitit ja paperiliittimet (poikkeus: turvallisuustasojen P6 ja P7 laitteet).

Kulutus, epäasianmukaisesta käytöstä johtuvat vauriot sekä ulkopuolisen suorittamat toimenpiteet eivät kuulu tuotevastuun eivätkä takuun piiriin

Asiakirjasilppuri on suunniteltu käytettäväksi yksityiskojeissa ja normaalissa toimistoympäristössä.

Teknisissä tiedoissa ilmoitetun suorituskyvyn saavuttaminen riippuu seuraavista seikoista:

Yksittäisten, silputtavien arkkien enimmäismäärä seuraavissa olosuhteissa: Uudet tai öljytyt leikkausterät, kylmä moottori, teholähde nimellisjännitteellä ja -taajuudella (230V/50 Hz, 120V/60 Hz). Poikkeamat näistä voivat johtaa huonompaan suorituskykyyn ja melun lisääntymiseen. Arkit syötetään keskitetysti ja pituussuunnassa, 90° kulmassa. Arkkien käsittelyteho voi myös vaihdella paperin ominaisuuksista ja syöttötavasta riippuen.

1.2 Turvallisuusohjeet







- Tarkista, että sähköverkkoosi jännite ja taajuus täsmäävät tyyppikyltin tietojen kanssa.
- Älä aseta laitetta lämmönlähteen lähelle!
- Säilytä, kuljeta ja käytä laitetta ainoastaan pystyasennossa!
- Käytä laitteessa vain nesteitä ja kaasuja, jotka täyttävät DAHLEN vaatimukset!
- Käytä laitetta ainoastaan suljetuissa tiloissa 10–25 °C:ssa (50–77 °F:ssa) ja tiivistymättömässä 15–95 %:n ilmankosteudessa!
- Laitetta ei saa avata!
- Rakennuksen asennusten oikosulkusuojaus on taattava: maks. 16 A (US maks. 20 A).
- Älä käytä laitetta tyhjänä!

- Laitetta ei ole tarkoitettu sellaisten henkilöiden käytettäväksi (lapset mukaan luettuna), joiden fyysiset, aistilliset tai henkiset kyvyt ovat rajoitettuja tai joilta puuttuu kokemus ja tieto, elleivät he työskentele valvonnan alaisina tai saa perusteellista ohjetta laitteen käytöstä turvallisuudesta vastaavalta henkilöltä.



Hävitä asiakirjasilppuri ammattimaisesti ja ympäristöystävällisesti valtuutetussa keräyspisteessä. Asiakirjasilppurin osia tai pakkausta ei saa laittaa talousjätteen sekaan.

1.3 Merkkien selitykset

	Tärkeä tieto		Automaattinen käynnistys		Irrota asiakirjasilppuri virtalähteestä ennen huoltotöitä!
	Tietoa käyttäjälle/lue turvallisuusohjeet		Ei saa altistua kosteudelle		Tekniset tiedot – Oikeudet teknisiin muutoksiin pidätetään!
	HUOMIO		Tämä asiakirjasilppuri ei sovellu lasten käyttöön (laite ei ole leikkikalu).		Äänenvoimakkuus tyhjäkäynnissä
	HUOMIO! Sähköiskun vaara.		Paperinsyöttöön ei saa koskea käsin.		Sisäänvetonopeus
	HUOMIO, liikkuvat osat		Paperinsyöttöön ei saa laittaa vaatekappaleita!		Paperin suikaleikkaus
	HUOMIO, terävät reunat		Paperinsyöttöön ei saa laittaa hiuksia!		Paperin silppuleikkaus
	Asiakirjasilppuria ei saa käyttää syövyttävien aineiden läheisyydessä.		Pidä spraypullot kaukana!		CD/DVD-levyjen suikaleikkaus
	Aseta laite tukevasti lattialle 100 mm:n etäisyydelle seinästä, vältä kuumentumista suman vuoksi, lukitse seisontajarrut (mallista riippuvainen)		Paperiliittimet ja niitit on poistettava ennen silppuamista!		CD/DVD silppuleikkaus
	Asiakirjasilppuria ei saa käyttää palavien nesteiden tai kaasujen läheisyydessä.		Älä syötä diskettejä!		Korttien suikaleikkaus
			CD-/DVD-levyjä hävitettäessä on käytettävä suojalaseja!		Korttien silppuleikkaus

1



Turvallisuustaso - P
Paperin silppuaminen



Turvallisuustaso - F
Mikrofilmin tuhoaminen



Turvallisuustaso - O
CD-, DVD-levyjen tuhoutuminen



Turvallisuustaso - T
Kortin tuhoaminen



Turvallisuustaso - E
Sirukortin tuhoutuminen



Paino



Verkkopistoke toimii virtalähteen katkaisijana.



Suojamaadoitetun verkkopistorasian on oltava aina helposti tavoitettavissa!



Käyttö



Asiakirjasilppuri valmiustilassa



Asiakirjasilppuri toiminnassa



Automaattinen sammutus!



Pidempiaikaisessa käytössä ja/tai ylikuormituksen vuoksi asiakirjasilppuri kytkeytyy automaattisesti pois päältä jäähtymään.



Huolto-ohjeet/häiriöiden korjaus



Silppusäiliö täynnä



Mahdolliset häiriöt



Automaattinen sammutus avatulla kotelolla



Ylikuumentuminen



Moottorin keskeytys

no Bruksanvisning



OBS!

FØR du tar i bruk makuleringsmaskinen må du lese nøye gjennom bruksanvisningen og sikkerhetsinstruksene.



Anvisningene må anvendes!

Oppbevar bruksanvisningen for senere bruk.

Innholdsfortegnelse

1	Viktig informasjon.....	31
1.1	Forskriftsmessig bruk, garanti	31
1.2	Sikkerhetsinstruksjer.....	31
1.3	Piktogramforklaring.....	32
1.4	Leveringsomfang.....	88
1.5	Tekniske data	88
2	Betjening.....	89
2.1	Fjerne transportlåsen.....	89
2.2	Koble apparatet til strømmettet.....	90
2.4	Slå på apparatet.....	90
2.5	Papirmakulering	91
2.8	Kontinuerlig fremdrift	92
2.9	CD/DVD-, kortmakulering	93
3	Vedlikehold/feilretting	95
3.1	Tøm skjæregods.....	95
3.3	Beholder åpen.....	95
3.4	Overopphetet	96
3.6	Papirfeil	96
3.7	Rengjør apparatet	97
3.9	Smør enheten	98

1.1 Forskriftsmessig bruk, garanti

Makuleringsmaskinen er konstruert for å makulere papir.

Avhengig av hvilken modell det dreier seg om, kan dessuten en liten mengde av de følgende materialene makuleres:

- CD-er/DVD-er, sjekk- og kredittkort (se Tekniske data).
- Binders og stifter som finnes i papirdokumenter i vanlig omfang (unntak: enheter i sikkerhetstrinn P6 og P7).

Slitasje, skader gjennom ufagmessig bruk samt inngrep fra tredje parter faller verken inn under forhandlergaranti eller produsentgaranti

Makuleringsmaskinen er konstruert til privat drift samt drift i normale kontoromgivelser.

Med hensyn til arkkapasiteten angitt under tekniske data gjelder følgende rammebetingelser:

Maksimalt antall ark som kan kuttes i en gjennomgang under følgende betingelser: Nye eller smurte kuttevalser, kald motor, strømforsyning med nominell spenning og frekvens (230V/50Hz; 120V / 60Hz). Avvik kan føre til en lavere arkkapasitet og høyere driftsstøy. Arkene mates inn midtstilt og i lengderetningen ved 90°. Arkkapasiteten kan også variere alt etter papiregenskaper og tilførsel.

1.2 Sikkerhetsinstruksjer

- Kontroller at spenningen og nettfrekvensen i strømmettet ditt stemmer overens med informasjonen på typeskiltet.
- Apparatet må ikke plasseres i nærheten av en varmekilde!
- Apparatet må kun lagres, transporteres og brukes stående!
- Man må kun benytte væsker og gass som tilsvarer DAHLE-direktivene på apparatet!
- Apparatet skal ikke åpnes!
- Ikke la apparatet gå på tomgang!
- Apparatet skal kun brukes i lukkede rom ved tempe-



raturer fra 10 °C til 25 °C (50 °F bis 77 °F) og en ikke-kondenserende luftfuktighet fra 15 % til 95 %!























- Det må sørges for sikkerhet mot kortslutning av bygningssinnstallasjonen: maks. 16 A (US maks. 20 A).
- Matekanaler må kun brukes enkeltvis!
- Apparatet er ikke bestemt til bruk av personer (gjelder også barn) med innskrenkede fysiske, sensoriske eller åndelige evner eller manglende erfaring og kunnskaper, med mindre de arbeider under tilsyn eller får en utførlig veiledning til bruken av apparatet av en person som er ansvarlig for sikkerheten.



Makuleringsmaskinen må kastes faglig korrekt og miljøvennlig ved et autorisert samlested for avfall. Ingen deler av makuleringsmaskinen eller emballasjen får kastes i husholdningsavfallet.

1.3 Piktogramlegende

	Viktig informasjon		Må ikke benyttes i nærheten av brennbare væsker eller gass.		Ikke før inn disketter!
	Les brukerinformatjonen/sikkerhetsinstruksene		Automatisk start		Når du ødelegger CD/DVD-er må du bruke en vernebrille!
	OBS		Må ikke utsettes for fuktighet		Før vedlikeholdsarbeid må makuleringsmaskinen kobles fra strømmettet!
	MERK FØLGENDE! Fare for elektrisk støt.		Denne makuleringsmaskinen er ikke ment til bruk av barn (produktet er ikke et leketøy).		Tekniske data - Forbehold om tekniske endringer!
	OBS, bevegelige deler		Ikke berør papirinntaket med hendene.		Driftslydstyrke på tomgang
	OBS, skarpe kanter		Ikke berør papirinntaket med klesplagg!		Inntrekkshastighet
	Må ikke benyttes i nærheten av etsende stoffer.		Ikke berør papirinntaket med hårene!		Papir-stripesnitt
	Apparatet må plasseres stabilt på gulvet med en avstand på 100 mm til veggen, unngå oppvarming på grunn av kø/blokkering, Betjen parkeringsbremsen (typeavhengig)		Spraybokser må holdes unna!		Papir-partikkelsnitt
			Fjern binders og heftestifter før makulering!		CD/DVD-levyen suikaleikkaus

- | | | | | | |
|--|--|---|---|---|--|
|  | CD/DVD-partikkelsnitt |  | Vekt |  | Ved lengre drift og/eller overbelastning slås makuleringsmaskinen automatisk av for avkjøling. |
|  | Kort-stripesnitt |  | Strømkontakten brukes som skilleanordning for strømforsyningen. |  | Vedlikeholdsinstrukser/ feilretting |
|  | Kort-partikkelsnitt |  | Jordet stikkontakt må alltid være lett tilgjengelig. |  | Beholder full |
|  | Sikkerhetsnivå - P
Makulering av papir |  | Betjening |  | Mulige feil |
|  | Sikkerhetsnivå - F
Ødeleggelse av mikrofilm |  | Makuleringsmaskin i beredskap |  | automatisk utkobling ved åpent hus |
|  | Sikkerhetsnivå - O
CD, DVD-ødeleggelse |  | Makuleringsmaskin i drift |  | Overopphetet |
|  | Sikkerhetsnivå - T
Kortødeleggelse |  | Automatisk utkobling! |  | Motorblokkering |
|  | Sikkerhetsnivå - E
Ødeleggelse av chipkort | | | | |

sv Bruksanvisning

**OBS!**

Läs uppmarksamt igenom bruksanvisningen och säkerhetsanvisningarna **INNAN** dokumentförstöraren tas i drift.



Anvisningarna måste tillämpas!

Förvara bruksanvisningen för senare användning.

Innehållsförteckning

1	Viktig information	34
1.1	Ändamålsenlig användning, garanti	34
1.2	Säkerhetsanvisningar	35
1.3	Piktogramförklaring	35
1.4	Leveransens omfattning	88
1.5	Tekniska data	88
2	Manövrering	89
2.1	Ta bort transportlåset	89
2.2	Ansluta apparaten till elnätet	90
2.4	Slå på apparaten	90
2.5	Förstöra dokument	91
2.8	Permanent drift	92
2.9	Förstöra CD/DVD-skivor och kort	93
3	Underhåll/felavhjälpning	95
3.1	Tömning av skuret material	95
3.3	Behållare öppet	95
3.4	Överhettning	96
3.6	Pappersblockering	96
3.7	Rengöring av apparaten	97
3.9	Olje av apparaten	98

1.1 Ändamålsenlig användning, garanti

Dokumentförstöraren är avsedd för förstörelse av papper.

Allt efter modellvariant kan dessutom smärre mängder av följande material förstöras:

- cd-/dvd-skivor, bank- och kreditkort (se Tekniska data).
- vanliga häftklamrar och gem som används i pappersdokument (undantag: apparater med säkerhetsnivå P6 och P7).

Slitage, skador pga. felaktig användning samt ingrepp genom tredje part faller varken under den lagstadgade garantin eller tillverkarens garanti.

Dokumentförstöraren är utformad för att användas privat och i vanlig kontorsmiljö.

För bladeffekten som anges under tekniska data gäller följande förutsättningar:

Maximalt antal blad som får skäras i en genomgång under följande förutsättningar: Nya eller oljade skärvalsar, kall motor, strömförsörjning med märkspänning och märkfrekvens (230V/50 Hz; 120V/60 Hz). Avvikelser kan leda till lägre bladeffekt och ökat driftsljud. Bladen matas in centrerat och på längden under 90°. Bladeffekten kan också variera beroende på pappersegenskaper och inmatning.

1.2 Säkerhetsanvisningar

- Kontrollera att elnätets spänning och nätfrekvens överensstämmer med uppgifterna på typskylten.
- Ställ inte upp apparaten i närheten av en värmekälla!
- Förvara, transportera och använd apparaten endast stående!
- Använd endast vätskor och gaser på apparaten som motsvarar DAHLE-riktlinjerna!
- Apparaten får inte öppnas!
- Använd endast apparaten inomhus, vid 10°C till 25°C (50°F till 77°F) och en ej kondenserande luftfuktighet på 15% till 95%!
- Se till att fastighetens installation är kortslutningssäker: max. 16A (USA max. 20A).
- Använd inte apparaten på tomgång!

- Apparaten är inte avsedd att användas av personer (inklusive barn) med nedsatt fysisk, sensorisk eller mental kapacitet eller bristande erfarenhet och kunskap, såvida de inte arbetar under uppsikt eller erhåller en utförlig anvisning om hur apparaten används av en person som ansvarar för säkerheten.



Avfallshandla dokumentförstöraren korrekt och miljörättligt hos ett auktoriserat uppsamlingsställe. Kasta in några delar av dokumentförstöraren eller förpackningen i hushållssoporna.

1.3 Piktogramförklaring

	Viktig information		Automatisk start		Koppla bort dokumentförstöraren från elnätet innan underhållsarbeten påbörjas!
	Läs användarinformati- onen/säkerhetsanvisning- arna		Utsätt inte apparaten för väta.		Tekniska data - Med reser- vation för tekniska änd- ringar!
	OBS!		Denna dokumentförstö- rare får inte användas av barn (produkten är ingen leksaker)!		Driftsljudnivå på tomgång
	UPPMÄRKSAMHET! Risk för elektrisk stöt.		Vidrör inte pappersinmat- ningen med händerna.		Inmatningshastighet
	OBS, rörliga delar		Vidrör inte pappersinmat- ningen med klädesplagg!		Papper strimlor
	OBS, skarpa kanter		Vidrör inte pappersinmat- ningen med håret!		Papper partikelsnitt
	Använd inte apparaten i närheten av frätande ämnen.		Håll sprayburkar på avstånd!		CD/DVD strimlor
	Placera apparaten stabilt på golvet och med 100 mm avstånd till väggen, und- vik värmeackumulering, använd parkeringsbromsen (typberoende)		Ta bort gem och häftklam- mer före förstörelseproces- sen!		CD/DVD partikelsnitt
	Använd inte apparaten i närheten av brännbara vätskor eller gaser.		Lägg inte in några disket- ter!		Kort strimlor
			Ha på dig skyddsglasögon när du förstör cd-/dvd- skivor!		Kort partikelsnitt

1



Säkerhetsnivå - P
Pappersförstöring



Säkerhetsnivå - F
Förstörelse av mikrofilm



Säkerhetsnivå - O
CD, DVD förstörelse



Säkerhetsnivå - T
Kort förstörelse



Säkerhetsnivå - E
Chipkort förstörelse



Vikt



Stickkontakten fungerar
som frånskiljningsanord-
ning för strömförsörj-
ningen.



Det jordade eluttaget
måste alltid vara lättått-
komligt!



Manövrering



Dokumentförstöraren i
beredskap



Dokumentförstöraren i
drift



Automatisk avstängning!



Vid längre drift och/eller
överbelastning stängs
dokumentförstöraren auto-
matiskt av för att svalna.



Underhållsanvisningar/
åtgärder vid störningar



Behållaren full



Möjliga störningar



automatisk frångkoppling
vid öppet hölje



Överhettning



Motorblockering

sl Navodilo za uporabo



POZOR!

PRED začetkom uporabe uničevalnika dokumentov pozorno preberite navodilo za uporabo in varnostne napotke.



Napotke morate upoštevati!
Navodilo za uporabo shranite za poznejšo uporabo.

Kazalo vsebine

1	Pomembne informacije	37
1.1	Namenska uporaba, jamstvo	37
1.2	Varnostna navodila	37
1.3	Legenda piktogramov	38
1.4	Obseg dobave	88
1.5	Tehnični podatki	88
2	Upravljanje	89
2.1	Odstranjevanje transportne ključavnice	89
2.2	Priključitev naprave na električno omrežje	90
2.4	Vklop naprave	90
2.5	Uničenje papirja	91
2.8	Neprekinjeno podajanje	92
2.9	Uničenje CD-jev/DVD-jev, kartic	93
3	Vzdrževanje/odpravljanje napak	95
3.1	Praznjenje razrezanega materiala	95
3.3	Odpirta pokrov	95
3.4	Pregrevanje	96
3.6	Zastoj papirja	96
3.7	Čiščenje naprave	97
3.9	Oljite napravo	98

1.1 Namenska uporaba, jamstvo

Uničevalnik dokumentov je namenjen uničenju papirja.

V odvisnosti od modela se lahko poleg papirja uničijo tudi majhne količine naslednjih materialov:

- CD/DVD, čekovne in kreditne kartice (glejte tehnične podatke).
- sponke za spenjanje in pisarniške sponke, ki so v običajnem obsegu vsebovane v papirni dokumentaciji (izjema: priprave varnostne stopnje P6 in P7).

Obraba, škoda zaradi nepravilne uporabe ter posegi tretjih oseb ne podlegajo ne jamstvu ne garanciji
Uničevalnik dokumentov je zasnovan za uporabo v zasebne namene in v običajnem pisarniškem okolju.

Glede na spodnje tehnične podatke o zmogljivosti obdelanih listov veljajo naslednji okvirni pogoji:

Največje število listov, ki bodo pod naslednjimi pogoji razrezani v enem postopku: Novi, morda naoljeni rezalni valji, hladni motor, napajanje s tokom z nazivno napetostjo in nazivno frekvenco (230V/50 Hz; 120V/60 Hz). Odstopanja lahko povzročijo manjšo zmogljivost obdelanih listov in glasnejši hrup delovanja. Liste je treba dovajati po sredini in pod kotom 90°. Odvisno od lastnosti papirja in dovajanja lahko prav tako odstopa zmogljivost obdelave listov.

1.2 Varnostni napotki

- Preverite, ali se napetost in frekvenca električnega omrežja ujemata s podatki na tipski tablici.
- Naprave ne postavljajte v bližino virov toplote.
- Napravo skladiščite, transportirajte in uporabljajte izključno v pokončnem položaju!
- Na napravi uporabljajte samo tekočine in pline, ki ustrezajo smernicam podjetja DAHLE!
- Naprave ne smete odpirati!
- Zagotovite, da je napeljava v zgradbi zaščiten pred kratkim stikom: maks. 16A (ZDA maks. 20A).
- Aparat uporabljajte samo v zaprtih prostorih pri temperaturi 10 °C do 25 °C (50 °F do 77 °F) in pri zračni vlažnosti brez nevarnosti kondenziranja od 15 % do 95 %!
- Naprava ne sme obratovati v prostem teku!
- Aparat ni namenjen uporabi s strani oseb (vključno



z otroki) z omejenimi fizičnimi, senzornimi ali duševnimi sposobnostmi ali s pomanjkljivimi izkušnjami in znanjem, razen, če delajo pod nadzorom ali pa jih oseba, odgovorna za varnost, temeljito pouči o uporabi naprave.



Uničevalnik dokumentov strokovno in okolju prijazno odvrzite med odpadke na pooblaščenem zbirnem mestu. Delov uničevalnika dokumentov ali embalaže ne mečite med hišne odpadke.

1.3 Legenda piktogramov

	Pomembne informacije		Ne izpostavljajte vlagi.		Tehnični podatki - pridržujemo si pravico do tehničnih sprememb!
	Preberite uporabniške informacije/varnostne napotke		Tega uničevalnika dokumentov ne smejo uporabljati otroci (izdelek ni igrača).		Obratovalna glasnost v prostem teku
	POZOR		Dovoda papirja se ne dotikajte z rokami.		Hitrost uvleka
	POZOR! Nevarnost električnega udara.		Dovoda papirja se ne dotikajte z oblačili!		Rezanje papirja na trakove
	POZOR, gibljivi deli		Dovoda papirja se ne dotikajte z lasmi!		Rezanje papirja na delce
	POZOR, ostri robovi		Razpršilnike držite proč od naprave!		Rezanje CD/DVD na trakove
	Ne uporabljajte v bližini jedkih snovi.		Pred uničevanjem dokumentov z njih odstranite vse sponke!		Rezanje CD/DVD na delce
	Napravo postavite na tla v stabilen položaj 100 mm od stene, preprečite zadrževanje toplote, pritegnite fiksne zavore (odvisno od tipa)		Ne vstavljajte disket!		Rezanje kartic na trakove
	Ne uporabljajte v bližini gorljivih tekočin ali plinov.		Pri uničevanju plošč CD/DVD morate nositi zaščitna očala!		Rezanje kartic na delce
	Avtomatski zagon		Pred vzdrževalnimi deli uničevalnik dokumentov odklopite od električnega napajanja!		Stopnja varnosti - P Drobljenje papirja



Stopnja varnosti - F
Uničenje mikrofilma



Stopnja varnosti - O
Uničenje CD, DVD



Stopnja varnosti - T
Uničenje kartice



Stopnja varnosti - E
Uničenje kartice s čipom



Teža



Omrežni vtič služi kot ločil-
na priprava električnega
napajanja.



Ozemljena električna vtič-
nica mora biti vedno zlahka
dostopna!



Upravljanje



Uničevalnik dokumentov v
pripravljenosti



Uničevalnik dokumentov v
obratovanju



Avtomatski izklop!



Pri dolgotrajnem obratova-
nju in/ali preobremenitvi
se uničevalnik dokumentov
avtomatsko izklopi, da se
ohladi.



Navodila za vzdrževanje /
odpravljanje napak



Posoda je polna



Možne motnje



avtomatski izklop pri odpr-
tem ohišju



Pregrevanje



Blokada motorja



hr Upute za uporabu



PAŽNJA!

PRIJE prve uporabe uništavača dokumenata pažljivo pročitajte Upute za uporabu i sigurnosne napomene i pridržavajte ih se!



Obavezno poštujujte sve napomene!
Sačuvajte ove upute za kasniju uporabu.

Sadržaj

1	Važne informacije	40
1.1	Namjenska uporaba, jamstvo	40
1.2	Sigurnosne upute	40
1.3	Legenda piktograma	41
1.4	Opseg isporuke	88
1.5	Tehnički podaci	88
2	Uporaba	89
2.1	Uklanjanje transportne brave	89
2.2	Priključivanje uređaja na električnu mrežu.....	90
2.4	Uključivanje uređaja	90
2.5	Uništavanje dokumenata	91
2.8	Trajno uvlačenje	92
2.9	Uništavanje CD-a, DVD-a, kartica	93
3	Održavanje/otklanjanje smetnji	95
3.1	Pražnjenje odrezaka	95
3.3	Spremnik otvoren	95
3.4	Pregrijavanje	96
3.6	Zastoj papira	96
3.7	Čišćenje stroja	97
3.9	Nauljite stroja	98

1.1 Namjenska uporaba, jamstvo

Uništavač dokumenata namijenjen je uništavanju papira.

Ovisno o vrsti modela, moguće je uništavanje manje količine sljedećih materijala:

- CD-i, DVD-i, čekovne i kreditne kartice (vidi Tehničke podatke).
- spajalice i klamerice koje se nalaze u papirnatnoj dokumentaciji u uobičajenoj količini (iznimka: uređaji sa stupnjem sigurnosti P6 i P7).

Trošenje, oštećenja zbog neprikladne uporabe i zahvati trećih strana nisu obuhvaćeni jamstvom ni garancijom. Uništavač dokumenata namijenjen je za privatnu uporabu i uobičajeno uredsko poslovanje.

U vezi s količinom listova koja je navedena u tehničkim podacima, vrijede sljedeći okvirni uvjeti:

Maksimalni broj listova koji se mogu izrezati u jednom prolazu pri sljedećim uvjetima: Novi i prema potrebi podmazani valjci za rezanje, hladan motor, napajanje strujom s nazivnim naponom i nazivnom frekvencijom (230V/50Hz; 120V/60Hz). Odstupanja mogu dovesti do smanjene količine listova i povećane buke pri okretanju. Listove treba umetati po sredini i uzdužno pod kutom od 90°. Ovisno o svojstvima papira i načinu umetanja, također može varirati i količina listova.

1.2 Sigurnosne upute

- Provjerite odgovaraju li napon i frekvencija mreže vaše električne mreže podacima na natpisnoj pločici.
- Nemojte uređaj postaviti u blizini izvora topline!
- Ovaj stroj skladištite, prevozite i koristite isključivo u uspravnom položaju!
- Prilikom rada stroja koristite samo tekućine i plinove koji ispunjavaju zahtjeve iz smjernica tvrtke DAHLE!
- Uređaj se ne smije otvarati!
- Stroj ne smije raditi u praznom hodu!
- Uređaj upotrebljavajte isključivo u zatvorenim prostorima na temperaturi od 10 °C do 25 °C (50 °F do 77 °F) i na vlažnosti zraka bez kondenzacije od 15 % do 95 %!
- Instalacije zgrade treba osigurati od kratkog spoja: maks. 16A(SAD maks. 20A).
- Otvore za uvlačenje koristiti samo pojedinačno!

- Uređajem ne smiju rukovati osobe (uključujući djecu) s ograničenim fizičkim, osjetilnim ili intelektualnim sposobnostima ili s nedostatkom iskustva i znanja, osim ako rade pod nadzorom ili ih je osoba odgovorna za sigurnost iscrpno upozнала s rukovanjem uređajem.



Uništavač dokumenata zbrinite stručno i u skladu s propisima o zaštiti okoliša na ovlaštenom deponiju. Dijelove uništavača dokumenata ili ambalaže ne odlažite u kućanski otpad.

1.3 Legenda pitkograma

	Važne informacije		Automatsko pokretanje uređaja		Prije radova održavanja isključite uništavač dokumenata iz napajanja strujom!
	Pročitajte korisničke informacije/sigurnosne napomene		Uređaj nemojte izlagati vlazi		Tehnički podaci - Pridržano pravo tehničkih izmjena!
	PAŽNJA		Ovim uništavačem dokumenata ne smiju rukovati djeca (proizvod nije igračka).		Razina buke pri radu u praznom hodu
	PAŽNJA! Opasnost od strujnog udara.		Otvor za ulaganje papira nemojte dodirivati rukama.		Brzina uvlačenja
	PAŽNJA pokretni dijelovi		Otvor za ulaganje papira ne dodirujte komadima odjeće!		Rezanje papira u trake
	PAŽNJA, oštri rubovi		Otvor za ulaganje papira ne dodirujte kosom!		Rezanje papira u sitne dijelove
	Uređaj nemojte koristiti u blizini korozivnih tvari.		Držite podalje od sprejeva!		Rezanje CD-a/DVD-a u trake
	Stroj postavite na čvrsto tlo na udaljenosti 100 mm od zida i izbjegavajte gomi-lanje topline! Aktivirajte kočnice za zaustavljanje (ovisno o tipu)		Prije uništavanja dokumenata ukloniti spajalice i klamerice!		Rezanje CD-a/DVD-a u sitne dijelove
	Uređaj nemojte koristiti u blizini zapaljivih tekućina ili plinova.		Nemojte uvoditi diskete!		Rezanje kartica u trake
			Prilikom uništavanja CD-a/DVD-a treba nositi zaštitne naočale!		Rezanje kartica u sitne dijelove



Razina sigurnosti - P
Sječkanje papira



Razina sigurnosti - F
Uništavanje mikrofilma



Razina sigurnosti - O
Uništavanje CD-a, DVD-a



Razina sigurnosti - T
Uništavanje kartice



Razina sigurnosti - E
Uništite kartice s čipom



Masa



Utikač služi za odvajanje
električnog napajanja



Mrežna utičnica s uzemlje-
njem mora uvijek biti lako
pristupačna!



Uporaba



Uništavač dokumenata u
stanju pripravnosti



Uništavač dokumenata u
radu



Automatsko isključivanje!



Kod dužeg rada i/ili preop-
terećenja uništavač doku-
menata se automatski gasi
radi hlađenja.



Napomene o održavanju/
otklanjanje smetnji



Spremnik pun



Moguće smetnje



automatsko gašenje kod
otvorenog kućišta



Pregrijavanje



Pregrijavanje



Blokada motora

hu Használati utasítás



FIGYELEM!

Az iratmegsemmisítő üzembe helyezése ELŐTT figyelmesen olvassa el a kezelési és biztonsági utasításokat.



Az utasításokat alkalmazni kell. Őrizze meg a kezelési utasítást a későbbi használathoz.

Tartalomjegyzék

1	Fontos információk	43
1.1	Rendeltetés szerinti használat, garancia	43
1.2	Biztonsági előírások	43
1.3	A piktogramok jelmagyarázata	44
1.4	A szállítmány tartalma	88
1.5	Műszaki adatok	88
2	Kezelés	89
2.1	A szállítási zár eltávolítása	89
2.2	A készülék hálózatra kapcsolása	90
2.4	A készülék bekapcsolása	90
2.5	Papír megsemmisítés	91
2.8	Tartós előre menet	92
2.9	CD/DVD- és kártyamegsemmisítés	93
3	Karbantartás/hibaelhárítás	95
3.1	A vágott anyag ürítése	95
3.3	Konténer nyitva	95
3.4	Túlmelegedés	96
3.6	Papír elakadás	96
3.7	A készülék tisztítása	97
3.9	Olajozza meg a készüléket	98

1.1 Rendeltetés szerinti használat, garancia

Az iratmegsemmisítő papírok megsemmisítésére készült. Egyes modellek kis mennyiségben alkalmasak a következő anyagok megsemmisítésére is:

- CD-k/DVD-k, csekk- és hitelkártyák (lásd a műszaki adatokat).
- a papírdokumentumokban a szokásos felhasználói terjedelemben előforduló tűző- és irodai kapcsok (kivételek: P6 és P7 biztonsági fokozatú készülékek).

A kopásból, nem rendeltetészerű használatból és külső beavatkozásokból származó károkokra a garancia nem érvényesíthető

Az iratmegsemmisítő magáncélú és normál irodai környezetben történő használatra készült.

Az alábbi műszaki adatokban megadott lapszámra vonatkozóan az alábbi keretfeltételek vonatkoznak: Az egy ciklusban, az alábbi feltételek mellett vágható lapok maximális darabszáma: Új, szükség esetén bealajozott aprítóhengerek, hideg motor, áramellátás névleges feszültséggel és névleges frekvencia (230V/50 Hz; 120V/60 Hz). Az adatoktól eltérés kisebb lapszámhoz vezethet és a készülék működése nagyobb zajjal járhat. A lapok adagolása közepén és hosszában 90°-nál kisebb szögben történik. A papír tulajdonságaitól és az adagolástól függően a darabszám változhat.

1.2 Biztonsági utasítások

- Ellenőrizze, hogy az elektromos hálózat feszültsége és frekvenciája megfelel-e az adattáblán szereplő értékeknek.
- Biztonsági utasítások
- A készüléket nem szabad hőforrások közelében elhelyezni.
- A készülék kizárólag álló helyzetben tárolható, szállítható és üzemeltethető.
- A készülékhez csak olyan folyadékokat és gázokat használjon, amelyek megfelelnek a DAHLE előírásainak.
- A készüléket tilos felnyitni.
- A készüléket kizárólag zárt helyiségekben, 10 és 25 °C közötti hőmérsékleten, kondenzációmentes, 15 és 95 % közötti páratartalom mellett üzemeltesse.

- Az épület elektromos hálózatában biztonsági rövidzárlat-védelmet kell felszerelni: max. 16 A (US max. 20 A).
- Ne működtesse üresen a készüléket.
- A készülék nem csökkent fizikai, érzékszervi vagy szellemi képességű, vagy tapasztalat és ismeretek nélküli személyek (ideértve a gyerekeket is) által történő használatra készült, kivéve, ha felügyelet mellett használják a készüléket vagy a készülék használatához részletes utasítást kapnak egy olyan személytől, aki a biztonságért felelős.



Az iratmegsemmisítőt szakszerű, környezetbarát módon selejtezze le és adja le egy átvételre jogosult gyűjtőhelyen. Az iratmegsemmisítő vagy a csomagolás semmilyen részét ne helyezze a háztartási hulladék közé.

1.3 Piktogramok magyarázata



Fontos információ



Olvassa el a kezelési/biztonsági utasításokat



FIGYELEM



FIGYELEM! Áramütés veszélye.



FIGYELEM, mozgó alkatrészek



FIGYELEM, éles szélek



Ne használja maró anyagok környezetében.



A készüléket biztonságosan állítsa a talajra a faltól 100 mm távolságra és ne hagyja, hogy a hó felhalmozódjon benne. Nyomja le a rögzítőféket (típusfüggő).



Ne használja gyúlékony folyadékok vagy gázok környezetében.



Automatikus indítás



Ne használja nedves környezetben.



A készüléket nem gyermekek általi használatra tervezték (a termék nem játék).



Ne érjen hozzá kézzel a papíradagolóhoz.



Ne érjen hozzá a ruhájával a papíradagolóhoz.



Ne érintse haját a papíradagolóhoz.



Tartsa távol a szóróflakonokat.



Az iratok megsemmisítése előtt távolítsa el belőlük a tűzkapcsokat és gemkapcsokat.



Ne helyezzen be lemezeket.



CD/DVD lemezek megsemmisítésekor védőszemüveget kell viselni!



A karbantartás előtt válassza le az iratmegsemmisítőt az elektromos hálózatról.



Műszaki adatok – A műszaki változtatások jogát fenntartjuk.



Zajszint üresjáratban



Behúzási sebesség

























Papír – csíkokra vágás



Papír – keresztvágás



CD/DVD – csíkokra vágás

	CD/DVD – keresztvágás		Tömeg		Az iratmegsemmisítő hosszú használat és/vagy túlterhelés miatt automatikusan leáll, hogy lehűlhessen.
	Kártyák – csíkokra vágás		A hálózati dugó az áramellátás leválasztására szolgál.		Karbantartási utasítások/hibaelhárítás
	Kártyák – keresztvágás		A védőföldeléses hálózati dugaszoló aljzatnak mindig hozzáférhetőnek kell lennie!		Megtelt a tartály
	Biztonsági szint - P Papíraprítás		Kezelés		Lehetséges problémák
	Biztonsági szint - F Mikrofilm megsemmisítése		Az iratmegsemmisítő használatra kész		Automatikus kikapcsolás nyitott fedélnél
	Biztonsági szint - O CD, DVD megsemmisítése		Az iratmegsemmisítő működik		Túlmelegedés
	Biztonsági szint - T Kártya megsemmisítése		Automatikus kikapcsolás!		Blokada motorja
	Biztonsági szint - E Pusztítsd el a chipkártyákat				



ru Инструкция по применению



ВНИМАНИЕ!

ПЕРЕД вводом в эксплуатацию машины для уничтожения деловых бумаг внимательно прочитайте руководство по эксплуатации и указания по технике безопасности.



Строго придерживайтесь указаний!

Сохраните руководство по эксплуатации для использования в будущем.

Оглавление

1	Важная информация.....	46
1.1	Применение по назначению, гарантийные обязательства	46
1.2	Указания по технике безопасности.....	46
1.3	Объяснение пиктограмм	47
1.4	Комплект поставки	88
1.5	Технические характеристики	88
2	Работа с устройством.....	89
2.1	Снятие транспортного замка	89
2.2	Подключение устройства к электросети	90
2.4	Включение устройства	90
2.5	Уничтожение бумаг	91
2.8	Режим непрерывной работы	92
2.9	Уничтожение CD/DVD-дисков и пластиковых карт.	93
3	Техническое обслуживание и устранение неисправностей	95
3.1	Удаление разрезанного материала.....	95
3.3	Емкость открыта	95
3.4	Перегрев.....	96
3.6	Замятие бумаги	96
3.7	Очистка устройства.....	97
3.9	Смажьте устройство маслом.....	98

1.1 Применение по назначению, гарантийные обязательства

Этот аппарат предназначен для уничтожения деловых бумаг.

В зависимости от модели аппарат может также уничтожить небольшое количество следующих материалов:

- CD-/DVD-диски, чековые и кредитные карточки (см. раздел «Технические характеристики»);
- скобы и скрепки, используемые для скрепления обычной документации (исключение: оборудование с уровнем секретности P6 и P7).

Гарантийные обязательства не распространяются на износ и повреждения, вызванные ненадлежащим использованием аппарата или вмешательством третьих лиц

Аппарат предназначен для домашнего пользования и для офисов с небольшим документооборотом.

Для указанной в технических характеристиках производительности (в листах бумаги) действуют следующие общие условия:

Максимальное количество листов, которое можно разрезать за один цикл при следующих условиях: новые или смазанные маслом режущие валы, холодный мотор, питание от сети с номинальным напряжением и частотой (230 В/50 Гц; 120 В/60 Гц). Отклонения могут привести к снижению производительности (в листах бумаги) и повышению шума во время работы. Листы подаются по центру в продольном направлении под углом 90°. Производительность зависит от свойств бумаги и способа подачи.

1.2 Указания по технике безопасности

- Убедитесь, что напряжение и частота используемой электросети соответствуют данным, приведенным на информационной табличке.
- Указания по технике безопасности
- Не устанавливать машину вблизи источников тепла!
- Машину следует хранить, транспортировать и использовать только в вертикальном положении!
- Возле машины использовать только жидкости и газы, соответствующие директивам компании DAHLE!
- Открывать машину запрещено!

- Использовать аппарат только в закрытых помещениях при температуре от 10 до 25°C (от 50 до 77°F) и влажности воздуха, не способствующей образованию конденсата (от 15 до 95 %)!
 - Обеспечить защиту проводки здания от коротких замыканий: макс. 16 А (в США — макс. 20 А).
 - Не допускать работы машины на холостом ходу!
 - Аппарат не предназначен для использования лицами (включая детей) с ограниченными физическими, сенсорными или умственными способностями, а также лицами, не обладающими надлежащим опытом и знаниями, за исключением случаев, когда они работают под присмотром или получили инструкции по эксплуатации аппарата от лица, ответственного за безопасность.



Утилизировать машину для уничтожения бумаг с учетом требований по охране окружающей среды, сдав ее в специализированный пункт сбора отходов. Не выбрасывать детали машины для уничтожения бумаг или компоненты упаковки вместе с бытовыми отходами.

1.3 Объяснение пиктограмм

	Важная информация		Установить машину устойчиво на полу на расстоянии 100 мм от стены, не допускать образования теплового застоя, активировать стопор (в зависимости от типа)		Не допускать контакта одежды с механизмом подачи бумаги!
	Прочитать информацию для пользователя/указания по технике безопасности		Не использовать рядом с воспламеняющимися жидкостями или газами.		Не допускать контакта волос с механизмом подачи бумаги!
	ВНИМАНИЕ		Не использовать рядом с воспламеняющимися жидкостями или газами.		Не хранить вблизи машины аэрозольные баллончики!
	ВНИМАНИЕ! Опасность поражения электрическим током.		Автоматический запуск		Перед процессом уничтожения снять с бумаги все скрепки и скобы!
	ВНИМАНИЕ, движущиеся части		Не подвергать воздействию влаги		Не использовать для уничтожения дискет!
	ВНИМАНИЕ, острые края		Данная машина для уничтожения бумаг не предназначена для использования детьми (изделие не является игрушкой).		При уничтожении CD/DVD-диска следует носить защитные очки!
	Не использовать вблизи едких веществ.		Не прикасаться руками к механизму подачи бумаги.		Перед проведением работ по техническому обслуживанию отключить машину от электропитания!



Технические характеристики – Возможны технические изменения!



уровень безопасности - F уничтожение микрофильмов



Автоматическое выключение!



Уровень рабочего шума на холостом ходу



уровень безопасности - O CD, DVD уничтожение



При длительной эксплуатации и/или перегрузке машина для уничтожения бумаг автоматически отключается для остывания.



Скорость подачи



уровень безопасности - T уничтожение карты



Указания по техническому обслуживанию/устранение неисправностей



Продольная резка бумаги



уровень безопасности - E уничтожение чип-карты



Емкость заполнена



Перекрестная резка бумаги



Масса



Возможные неисправности



Продольная резка CD/DVD-дисков



Сетевой штекер используется для отсоединения от электросети.



автоматическое отключение при открывании корпуса



Перекрестная резка CD/DVD-дисков



Обеспечьте постоянный быстрый доступ к заземленной розетке!



Перегрев



Продольная резка пластиковых карт



Работа с машиной



Индикатор блокировки двигателя



Перекрестная резка пластиковых карт



Машина для уничтожения деловых бумаг в состоянии готовности



уровень безопасности - P измельчение бумаги



Машина для уничтожения деловых бумаг в рабочем состоянии

et Juhised



TÄHELEPANU!

Lugege kasutusjuhend ja ohutusjuhised tähelepanelikult ENNE paberipurustaja kasutamist läbi.



Juhistest tuleb kinni pidada!

Hoidke kasutusjuhend hilisemaks kasutamiseks alles.

Sisukord

1	Tähtis teave	49
1.1	Sihtotstarbeline kasutamine, garantii	49
1.2	Ohutusjuhised	50
1.3	Piktogrammide legend	50
1.4	Pakendi sisu	88
1.5	Tehnilised andmed	88
2	Käsitsemine	89
2.1	Transpordiluku eemaldamine	89
2.2	Seadme ühendamine vooluvõrku	90
2.4	Seadme sisselülitamine	90
2.5	Paberi purustamine	91
2.8	Püsirežiim	92
2.9	CD-/DVD-plaatide ja kaartide purustamine	93
3	Hooldus/tõrgete kõrvaldamine	95
3.1	Purustatud materjali kõrvaldamine	95
3.3	Mahuti avatud	95
3.4	Ülekuumenemine	96
3.6	Paberiummistus	96
3.7	Seadme puhastamine	97
3.9	Õlitage seadet	98

1.1 Sihtotstarbeline kasutamine, garantii

Paberipurustaja on mõeldud paberi purustamiseks.

Olenevalt mudelist võib väheses koguses purustada ka järgmisi materjale:

- CD-/DVD-plaadid, panga- ja krediitkaardid (vt Tehnilised andmed).
- paberdokumentides tavalisel kasutusmääral olevad klambrid ja kirjaklambrid (väljaarvatud P6 ja P7 ohustaseme seadmed).

Kulumisest, mittesihtotstarbelisest kasutamisest ja ka kolmandate isikute läbiviidud parandustöödest põhjustatud kahjud ei kuulu ei tagatise ega garantii alla.

Paberipurustaja on mõeldud kasutamiseks erasfääris ja tavapärasel bürookeskkonnas.

Tehnilistes andmetes esitatud lehe lõikamise võimsusele kehtivad alljärgnevad raamtingimused.

Maksimaalne arv lehti, mida ühe töökäiguga saab lõigata, kui tingimused on järgmised: uued, vajaduse korral õlitatud lõikerullikud, külm mootor, vooluvarustus nimipinge ja nimisagedusega (230V / 50Hz; 120V / 60Hz). Kõrvalekalle tagajärjeks võib lehtede lõikamise võimsus olla madalam ja müratase suurem. Lehed tuleb sisestada keskelt ja pikuti 90° nurga all. Ka paberi omadused ja sisestamise viis mõjutavad lehe lõikamise võimsust.



1.2 Ohutusjuhised

- Kontrollige, et teie vooluvõrgu pinge ja võrgusagedus vastavad tüübisildi andmetele.
- Seadet ei tohi paigutada soojusallika lähedusse!
- Seadet tohib ainult püstises asendis ladustada, transportida ja käitada!
- Kasutage seadmes ainult DAHLE nõuetele vastavaid vedelikke ja gaase!
- Seadet ei tohi avada!
- Seadet tohib kasutada vaid suletud ruumides, mille temperatuur jääb vahemikku 10 °C kuni 25 °C (50 °F kuni 77 °F) ja mittekontendseeruv õhuniiskus vahemikku 15% kuni 95%.
- Tagage hoone paigalduse lühisekindlus max 16A (US max 20A).

- Seadet ei tohi tühjalts käitada!
- Seade pole mõeldud kasutamiseks piiratud füüsiliste, sensoorsete või vaimsete võimetega isikute poolt (sh lapsed) või väheste kogemuste ja teadmistega, välja arvatud juhul, kui neid seadme kasutamisel juhendatakse või antakse üksikasjalikud juhised ohutuse eest vastutava isiku poolt.



Viige kõrvaldamisele kuuluv dokumendipurustaja ettenähtud korras ja keskkonnanahoidlikult heakskiidetud kogumiskohta. Ärge visake paberipurustaja osi ega pakendit tavalisse olmeprügisse.

1.3 Piktogrammide legend

	Oluline teave		Paigutage seade seinast 100 mm kaugusele põrandale seisma, tagage sooja õhu äravool. Rakendage seisupidurit (olenevalt mudelist)		Ärge puudutage paberi sisestusava riietega!
	Lugege kasutusteavet/ohutusmärkusi		Ärge kasutage seadet põlemisohutlike ainete või gaaside läheduses.		Ärge puudutage paberi sisestusava juustega!
	TÄHELEPANU		Ärge kasutage seadet põlemisohutlike ainete või gaaside läheduses.		Hoidke aerosoolpurgid eemal!
	TÄHELEPANU! Elektrilöögi oht.		Automaatne käivitumine		Enne purustamist eemaldage kirja- ja vihikuklambri!
	TÄHELEPANU, liikuvad osad		Ärge jätke niiskesse keskkonda		Ärge sisestage seadmesse diskette!
	TÄHELEPANU, teravad servad		Dokumentipurustaja ei sobi lastele kasutamiseks (toode pole mänguasi).		CD või DVD hävitamisel tuleb kanda kaitseprille!
	Ärge kasutage seadet hapeliste ainete läheduses.		Ärge puudutage paberi sisestusava kätega!		Enne hooldustöid lahutage paberipurustaja vooluvõrgust!

 Tehnilised andmed –tootjal on õigus teha tehnilisi muudatusi!

 Müratase seadme tühikäigu puhul

 Etteandekiirus

 Paberi ribastamine

 Paberi peenestamine

 CD-/DVD-plaatide ribastamine

 CD-/DVD-plaatide peenestamine

 Kaartide ribastamine

 Kaartide peenestamine

 Turvalisuse tase - P Paberi purustamine

 Turvalisuse tase - F Mikrofilmi hävitamine

 Turvalisuse tase - O CD, DVD hävitamine

 Turvalisuse tase - T Kaardi hävitamine

 Turvalisuse tase - E Kiipkaardi hävitamine

 Kaal

 Seadme saab vooluvõrgust eraldada pistiku abil.

 Kaitsemaandusega võrgupistikupesa peab olema igal ajal lihtsalt juurdepääsetav!

 Käsitsemine

 Paberipurustaja on kasutusvalmis

 Paberipurustaja töötab

 Automaatne väljalülitus!

 Pikemaajalise kasutamise ja/või ülekoormuse puhul lülitub dokumendipurustaja jahtumiseks automaatselt välja.

 Hooldusjuhised / tõrgete kõrvaldamine

 Mahuti on täis

 Võimalikud tõrked

 automaatne väljalülitamine avatud korpuse puhul

 Ülekuumenemine

 Mootori blokeerumise

lt Naudojimo instrukcija



DĖMESIO!

Prieš pradėdami naudoti dokumentų smulkintuvą atidžiai perskaitykite naudojimo instrukciją ir saugos instrukcijas.



Būtina vadovautis instrukcijomis!

Saugokite instrukcijas, kad paskaitytumėte ir vėliau.

Turinys

1	Svarbi informacija	52
1.1	Naudojimas pagal paskirtį, garantija	52
1.2	Saugos nurodymai	53
1.3	Piktogramos legenda	53
1.4	Komplektacija	88
1.5	Techniniai duomenys	88
2	Valdymas	89
2.1	Transportavimo užrakto nuėmimas	89
2.2	Prietaiso įjungimas į elektros tinklą	90
2.4	Prietaiso įjungimas	90
2.5	Popieriaus smulkinimas	91
2.8	Nuolatinės priekinės eigos režimas	92
2.9	CD / DVD, kortelių naikinimas	93
3	Techninė priežiūra / trikčių šalinimas	95
3.1	Nuokarpų pašalinimas	95
3.3	Surinkimo konteineris atidarytas	95
3.4	Perkaitimas	96
3.6	Popieriaus strigtis	96
3.7	Prietaiso valymas	97
3.9	Sutepkite prietaisą alyva	98

1.1 Naudojimas pagal paskirtį ir garantija

Dokumentų naikiklis skirtas popieriui naikinti.

Be to, priklausomai nuo modelio varianto, galima naikinti nedidelius toliau nurodytų medžiagų kiekius:

- CD ir DVD diskus, debetines ir kreditines korteles (žūrėkite skyrių „Techniniai duomenys“).
- popieriniuose dokumentuose esančias sąsagėles bei kanceliarines sąvaržėles, jei jų kiekis neviršija įprastai naudojamo (išimtis: P6 ir P7 saugumo klasių prietaisai).

Gedimams, atsiradusiems dėl susidėvėjimo, netinkamo naudojimo, o taip pat – dėl trečiųjų šalių atliktų intervencijų, netaikomi nei įstatymų numatyti garantiniai įsipareigojimai, nei gamintojo savanoriškai suteikiama garantija.

Dokumentų naikiklio konstrukcija yra pritaikyta naudoti buityje ir įprastinėje biuro aplinkoje.

Lapų apdorojimo našumui, nurodytam techniniuose duomenyje, galioja tokios pagrindinės sąlygos:

Maksimalus lapų skaičius, kurie vienos eigos metu pjaustomi tokiomis sąlygomis: Nauji, jeigu reikia, patepti pjaustymo velenėliai, šaltas variklis, maitinimo vardinė įtampa ir vardinis dažnis (230V / 50Hz; 120V / 60Hz). Nukrypstant nuo šių sąlygų lapų apdorojimo našumas gali būti mažesnis, o triukšmas veikiant prietaisui didesnis. Lapai tiekiami per vidurį ir išilgai, 90° kampu. Priklausomai į popieriaus savybių ir tiekimo, lapų apdorojimo našumas taip pat gali skirtis.

1.2 Saugos nuorodos

- Patikrinkite, ar jūsų elektros tinklo įtampa ir dažnis atitinka specifikacijų lentelėje nurodytus duomenis.
- Dokumentų smulkintuvo negalima statyti prie šilumos šaltinio!
- Įrenginį laikyti, gabenti ir naudoti leidžiama tik stačią!
- Su įrenginiu leidžiama naudoti tik tuos skysčius ir dujas, kurie atitinka DAHLE taikytinas direktyvas!
- Įrenginio negalima atidaryti!
- Saugant pastato elektros tinklą nuo trumpųjų jungimų turi būti įrengtas maks. 16Asaugiklis (JAV maks. 20 A).
- Prietaisą leidžiama naudoti tik uždaroje patalpose, esant 10–25 °C (50–77 °F) temperatūrai ir 15–95% oro drėgnei be kondensacijos!
- Nenaudokite tuščio įrenginio!

- Prietaisas nėra skirtas naudoti asmenims (įskaitant ir vaikus), kurių fiziniai, jutiminiai ar protiniai gebėjimai yra riboti, arba kuriems trūksta patyrimo ir žinių, išskyrus atvejus, kai jie dirba prižiūrimi arba už saugą atsakingas asmuo juos išsamiai instruktuoja, kaip naudotis prietaisu.



Dokumentų smulkintuvą utilizuokite techniniu požiūriu tinkamu ir aplinkai nekenksminu būdu, t. y. atiduokite jį įgaliojamai atliekų tvarkymo įmonei. Dokumentų smulkintuvo dalių ir pakuotės neišmeskite su buitinėmis atliekomis.

1.3 Piktogramos



Svarbi informacija



Skaityti naudotojo informaciją/saugos instrukcijas



DĖMESIO



DĖMESIO! Elektros smūgio pavojus.



DĖMESIO, judančios dalys



DĖMESIO, aštrūs kraštai



Draudžiama naudoti aparatą šalia edžių medžiagų.



Įrenginį reikia stabiliai pastatyti ant grindų 100 mm atstumu nuo sienos, saugoti nuo įkaitimo pavojaus, įjungti stabdymo mechanizmą (priklauso nuo įrenginio tipo).



Nenaudoti netoli degių skysčių arba dujų.



Automatinis įjungimas



Statykite tik ant sauso pagrindo



Šis dokumentų smulkintuvus neskirtas naudoti vaikams (gaminys nėra žaislas).



Nelieskite popieriaus tiektuvo rankomis.



Nekiškite prie popieriaus tiektuvo drabužių!



Nekiškite prie popieriaus tiektuvo plaukų!



Nelaikykite arti aerozolių!



Prieš naikindami dokumentus pašalinkite sąvaržėles ir sąsagėles!































Negalima naikinti diskelių!



Prieš naikindami DVD / kompaktinius diskus užsidėkite apsauginius akinius!



Prieš atlikdami priežiūros darbus dokumentų smulkintuvą atjunkite nuo maitinimo šaltinio!

	Techniniai duomenys - Galimi techniniai pakeitimai!		Saugumo lygis - F Mikrofilmų sunaikinimas		Įrenginys naudojimo metu
	Triukšmo lygis tuščiaja eiga		Saugumo lygis - O CD, DVD sunaikinimas		Automatinis išjungimas!
	Įtraukimo greitis		Saugumo lygis - T Kortelės sunaikinimas		Ilgą naudojimo ir (arba) perkrovos atveju dokumentų smulkintuvas išsijungia automatiškai, kad atvėstų.
	Popieriaus smulkinimas juostelėmis		Saugumo lygis - E Sunaikink lustines korteles		Techninės priežiūros / gedimų šalinimo instrukcijos
	Popieriaus smulkinimas į daleles		Masė		Prisip. dėžė
	CD/DVD smulkinimas juostelėmis		Tinklo kištukas skirtas elektros maitinimo šaltiniui atjungti!		Galimos triktys
	CD/DVD smulkinimas skiautėmis		Maitinimo tinklo kištukinis lizdas su apsauginiu žeminimu turi būti lengvai pasiekiamas!		Automatinis išjungimas, kai atidarytas dangtis
	Kortelių smulkinimas juostelėmis		Valdymas		Perkaitimas
	Kortelių smulkinimas į daleles		Įrenginys parengtas veikti		Variklio užblokavimas
	Saugumo lygis - P Dokumentų smulkinimas				

lv Lietošanas norādījumi



UZMANĪBU!

Pirms sākat izmantot dokumentu smalcinātāju, lūdzam uzmanīgi izlasīt lietošanas pamācību un drošības norādes!



Ievērojiet drošības norādes!
Saglabājiet lietošanas pamācību turpmāķai uzzīņai.

Satura rādītājs

1	Svarīga informācija	55
1.1	Paredzētais pielietojums un garantija	55
1.2	Drošības norādes	55
1.3	Paskaidrojumi par piktogrammām	56
1.4	Piegādes komplekts	88
1.5	Tehniskie dati	88
2	Lietošana	89
2.1	Transportēšanas slēdzenes noņemšana	89
2.2	Ierīces pievienošana strāvas tīklam	90
2.4	Ierīces ieslēgšana	90
2.5	Dokumentu smalcināšana	91
2.8	Ilgstoša darbība	92
2.9	CD/DVD un karšu smalcināšana	93
3	Apkope/traucējumu novēršana	95
3.1	Sasmalcinātās masas iztukšošana	95
3.3	Konteiners atvērts	95
3.4	Pārkaršana	96
3.6	Iestrēdzis papīrs	96
3.7	Ierīces tīrīšana	97
3.9	Ieeļļojiet ierīci	98

1.1 Paredzētais pielietojums un garantija

Dokumentu smalcinātājs ir paredzēts papīra sasmalcināšanai.

Daži ierīces modeļi var sasmalcināt arī nelielu tālāk norādīto materiālu daudzumu:

- CD/DVD, maksājumu kartes (skatiet sadaļu "Tehniskie dati");
- papīra dokumentos parastajā daudzumā ietvertās saspraudes un skavas (izņēmums: ierīces, kas atbilst drošības pakāpei P6 un P7).

Garantija neietver nodilumu, neprofesionālas lietošanas un trešās puses veiktu darbību dēļ radītus ierīces bojājumus.

Dokumentu smalcinātājs ir paredzēts lietošanai nekomerciālos nolūkos un parastā biroja vidē.

Uz tehniskajos datos norādīto lapu skaitu attiecas turpmākie robežnosacījumi:

Maksimālais lapu skaits, kas tiek sagrieztas vienā reizē ar šādiem nosacījumiem: jaunas un nepieciešamības gadījumā ieeļļotas griešanas velmes, auksts motors, nomināls barošanas spriegums un frekvence (230V/50Hz; 120V/60Hz). Novirzes var samazināt apstrādāto lapu skaitu un palielināt ekspluatācijas trokšņus. Lapas tiek padotas centrēti un gareniski 90° leņķī. Apstrādāto lapu skaits var mainīties atkarībā no papīra īpašībām un padeves veida.

1.2 Drošības norādes

- Pārbaudiet, vai pieejamā strāvas tīkla spriegums un frekvence atbilst norādēm uz datu plāksnītes.
- Ierīci nedrīkst uzstādīt karstuma avota tuvumā!
- Ierīce ir jāglabā, jāpārvadā un jāizmanto tikai vertikālā stāvoklī!
- Ierīcē drīkst izmantot tikai tādus šķidrumus un gāzes, kas atbilst DAHLE vadlīnijām!
- Ierīci nedrīkst atvērt!
- Ēkas elektroinstalācija ir jānodrošina pret īsslēgumu: maks. 16A(ASV maks. 20A)!
- Ierīci drīkst izmantot tikai slēgtā telpā, kur gaisa tem-



peratūra ir no 10 °C līdz 25 °C (no 50 °F līdz 77 °F) un kur gaisa mitrums no 15 % līdz 95 % neizraisa ūdens kondensāciju!

























- Nepieļaujiet ierīces darbību tukšgaitā!
- Ierīci nedrīkst lietot personas (tostarp bērni) ar iero-bežotām fiziskām, sensorām vai garīgām spējām vai nepietiekamu pieredzi un zināšanām, izņemot gadījumus, kad darbs tiek uzraudzīts vai par drošību atbildīgā persona ir veikusi visaptverošu apmācību par ierīces lietošanu.



Dokumentu smalcinātāju utilizējiet pareizā veidā – nododiet to apstiprinātā savākšanas punktā. Neizmetiet dokumentu smalcinātāja daļas vai tā iepakojumu kopā ar sadzīves atkritumiem.

1.3 Paskaidrojumi par piktogrammām

	Svarīga informācija		Neizmantot vidē, kur tuvumā ir viegli uzliesmojoši šķidrumi un gāzes.		Pirms smalcināšanas izņemiet no dokumentiem skavas un noņemiet saspraudes!
	Izlasīt paziņojumu lietotājam/drošības norādes		Automātiska darbības uzsākšana		Aizliegts smalcināt datora disketes!
	UZMANĪBU!		Sargāt no mitruma		Izņīcinot CD/DVD, ir jālieto aizsargbrilles!
	UZMANĪBU! Elektriskās strāvas trieciena risks.		Dokumentu smalcinātāju aizliegts lietot bērniem (šī ierīce nav rotaļlieta)!		Pirms smalcinātāja apkopes darbu sākuma atvienojiet ierīci no elektriskā tīkla!
	UZMANĪBU, kustīgās daļas		Aizliegts ar rokām pieskarties papīra padeves vadotnei.		Tehniskie rādītāji - iespējamas tehniskas izmaiņas!
	UZMANĪBU, asas malas		Nedrīkst pieļaut apģērba nonākšanu papīra padeves vadotnē!		Darbības troksnis tukšgaitā!
	Ierīces tuvumā nedrīkst atrasties kodīgas vielas.		Nedrīkst pieļaut matu nonākšanu papīra padeves vadotnē!		Ievilkšanas ātrums
	Stabili uzstādīt ierīci uz grīdas 100 mm attālumā no sienas, nepieļaut siltuma uzkrāšanos ap ierīci, iedarbināt fiksēšanas mehānismu (atkārībā no ierīces veida)		Sargāt no aerosoliem!		Papīra smalcināšana strēmēļēs

	Papīra smalcināšana gabalos		Drošības līmenis - E Iznīcīni čipkartes		Ilgākas darbināšanas vai pārslodzes gadījumā dokumentu smalcinātājs automātiski izslēdzas, lai atdzistu.
	CD/DVD smalcināšana strēmēlēs		Svars		Apkopes norādījumi / darbības traucējumu novēršana
	CD/DVD smalcināšana gabalos		Tikla kontaktspraudnis kalpo kā elektriskās strāvas padeves pārtraukšanas ierīce.		Tvertne pilna
	Karšu smalcināšana strēmēlēs		Lezemētajai strāvas tīkla kontaktligzdai vienmēr jābūt brīvi pieejamai!		Iespējamie traucējumi
	Karšu smalcināšana gabalos		Apkalpošana		automātiski izslēdzas, kad atver korpusu
	Drošības līmenis - P Papīra smalcināšana		Dokumentu smalcinātājs gatavs darbam		Pārkaršana
	Drošības līmenis - F Mikrofilmu iznīcināšana		Dokumentu smalcinātājs darbojas		Motora bloķēšana
	Drošības līmenis - O CD, DVD iznīcināšana		Automātiska izslēgšana!		
	Drošības līmenis - T Kartes iznīcināšana				



cs Návod k použití



UPOZORNĚNÍ!

Návod k obsluze a bezpečnostní pokyny ke skartovacímu zařízení si pozorně přečtěte PŘED jeho uvedením do provozu.



Dodržujte uvedené pokyny!

Návod k obsluze uchovejte pro případ pozdější potřeby.

Obsah

1	Důležité informace	58
1.1	Účelové použití, ručení	58
1.2	Bezpečnostní ustanovení	59
1.3	Popis piktogramů	59
1.4	Rozsah dodávky	88
1.5	Technické údaje	88
2	Obsluha	89
2.1	Demontáž přepravního zámku	89
2.2	Připojení přístroje k elektrické síti	90
2.4	Zapnutí přístroje	90
2.5	Skartování papíru	91
2.8	Trvalý chod vpřed	92
2.9	Skartování CD/DVD a karet	93
3	Údržba / odstraňování závad	95
3.1	Vyprázdnění rozřezaného materiálu	95
3.3	Kontejner otevřený	95
3.4	Přehřátí	96
3.6	Zaseknutý papír	96
3.7	Vyčistěte přístroj	97
3.9	Spotřebič naolejujte	98

1.1 Účelové použití, ručení

Skartovací zařízení je určeno ke skartování papíru. V závislosti na modelu je však možné skartovat také malá množství následujících materiálů:

- CD/DVD disky, šekové a kreditní karty (viz technické údaje).
- kancelářské sponky a drátky, které se nacházejí v papírových dokumentech v běžném množství (výjimka: zařízení bezpečnostního stupně P6 a P7).

Na opotřebení, poškození způsobené nevhodným používáním, stejně jako zásahy třetí strany, se nevztahuje ručení ani záruka.

Skartovací zařízení je koncipováno pro provoz v soukromém sektoru a v běžném kancelářském prostředí.

Kapacita skartace uvedená v technických údajích podléhá následujícím podmínkám:

Maximální počet současně skartovaných listů za následujících podmínek: Nové případně naolejované řezné válce, studený motor, napájení proudem při jmenovitých hodnotách napětí a frekvence (230V/50 Hz, 120V/60 Hz). Odchytky mohou vést ke snížení kapacity skartace a ke zvýšenému hluku. Listy se vkládají doprostřed a podélně pod 90° uhlím. V závislosti na vlastnostech a podávání papíru se kapacita skartace může také lišit.

1.2 Bezpečnostní upozornění





























- Přesvědčte se, zda napětí a kmitočet vaší elektrické sítě souhlasí s údaji na typovém štítku.
- Zařízení neumísťujte do blízkosti zdrojů tepla!
- Zařízení skladujte, přepravujte a provozujte pouze v poloze ve stoje.
- Na zařízení používejte pouze kapaliny a plyny odpovídající směrnicím společnosti DAHLE.
- Zařízení nikdy neotvírejte!
- Zajistěte ochranu instalace v budově proti zkratu: max. 16A (USA max. 20A).
- Provozujte zařízení výhradně v uzavřených místnostech při teplotě 10 °C až 25 °C (50 °F až 77 °F) a při nekondenzující vlhkosti vzduchu od 15 % do 95 %!
- Zařízení nenechávejte běžet naprázdno!
- Zařízení není určeno k používání osobami (včetně dětí)

s omezeními fyzickými, smyslovými nebo duševními schopnostmi nebo s nedostatečnými zkušenostmi a znalostmi, pokud nepracují pod dohledem nebo pokud se jim nedostane podrobného návodu k používání přístroje od osoby odpovědné za bezpečnost.



Skartovací zařízení nechte ekologicky a odborně zlikvidovat autorizovanou sběrnou. Nevyhazujte žádné díly skartovače nebo balení do domácího odpadu.

1.3 Popis piktogramů

	Důležitá informace		Automatický rozběh		Před prováděním údržby skartovač odpojit od přívodu proudu!
	Přečtěte si informace pro uživatele/bezpečnostní pokyny		Nepoužívejte ve vlhkém prostředí		Technické údaje — Technické změny vyhrazeny!
	POZOR		Toto skartovací zařízení není určeno pro děti (tento produkt není hračka).		Provozní hluknost při chodu naprázdno
	POZOR! Nebezpečí úrazu elektrickým proudem.		Otvoru pro vstup papíru se nedotýkejte rukama.		Rychlost vtahování
	POZOR, pohyblivé části		Zabraňte styku přívodu papíru s oblečením!		Řezání papíru na proužky
	POZOR, ostré hrany		Pozor, aby se do vstupu pro papír nedostaly vlasy!		Řezání papíru na kusy
	Nepoužívejte zařízení v blízkosti žíravých látek.		Uchovávejte spreje z dosahu přístroje!		Řezání CD/DVD na proužky
	Zařízení umístěte stabilně na podlahu s odstupem 100 mm ode zdi, tím zabráníte kumulaci tepla, zablokujte brzdy na kolečkách (podle typu zařízení)		Kancelářské sponky a sponky ze sešivaček před skartováním odstranit!		Řezání CD/DVD na kusy
	Nepoužívejte zařízení v blízkosti hořlavých kapalin nebo plynů.		Nevkládejte žádné disky!		Řezání karet na proužky
			Skartujte CD/DVD pouze s nasazenými ochrannými brýlemi!		Řezání karet na kusy

1



Úroveň zabezpečení - P
Skartování papíru



Úroveň zabezpečení - F
Zničení mikrofilmu



Úroveň zabezpečení - O
Zničení CD, DVD



Úroveň zabezpečení - T
Zničení karty



Úroveň zabezpečení - E
Zničte čipové karty



Hmotnost



Síťová zástrčka slouží jako
dělicí zařízení od napájení
ze sítě.



Elektrická síťová zástrčka
s ochranným uzemněním
musí být vždy lehce pří-
stupná!



Obsluha



Skartovač v provozní poho-
tovosti



Skartovač v provozu



Automatické vypínání!



Při delším provozu a/nebo
při přetížení se skartova-
cí zařízení automaticky
vypne, dokud nevychladne.



Pokyny pro údržbu/odstra-
ňování závad



Zásobník plný



Možné poruchy



automatické vypnutí při
otevření krytu



Přehřátí



Blokování motoru

sk Návod na použitie



POZOR!

PRED uvedením skartovacieho prístroja do prevádzky si pozorne prečítajte návod na obsluhu a bezpečnostné pokyny.



Pokyny sa musia aplikovať!

Návod na obsluhu si uschovajte na neskoršie použitie.

Obsah

1	Dôležité informácie	61
1.1	Použitie v súlade s určeným účelom, záruka	61
1.2	Bezpečnostné pokyny	61
1.3	Legenda piktogramov	62
1.4	Rozsah dodávky	88
1.5	Technické údaje	88
2	Obsluha	89
2.1	Odstránenie prepravného zámku	89
2.2	Pripojenie zariadenia k elektrickej sieti	90
2.4	Zapnutie prístroja	90
2.5	Skartácia papiera	91
2.8	Trvalý chod vpred	92
2.9	Skartácia CD/DVD, kariet	93
3	Údržba / odstraňovanie porúch	95
3.1	Odstránenie skartovaného materiálu	95
3.3	Otvorená nádrž / otvorený poklop	95
3.4	Prehriatie	96
3.6	Zaseknutie papiera pri ručnom vkladaní	96
3.7	Čistenie prístroja	97
3.9	Olejovanie prístroja	98

1.1 Použitie zariadenia v súlade s určeným účelom, poskytnutie záruky

Skartovací prístroj je určený na skartovanie papiera. Podľa variantu modelu je možné okrem toho skartovať malé množstvá nasledujúcich materiálov:

- CD/DVD disky, šekové a kreditné karty (pozri technické údaje).
- spinky a kancelárske spony nachádzajúce sa v papierových dokumentoch, v obvykle používanom rozsahu (výnimka: prístroje stupňa bezpečnosti P6 a P7).

Ručenie ani záruka sa nevzťahuje na opotrebovanie, škody spôsobené neodborným používaním ani zásahy tretej strany

Skartovací prístroj je koncipovaný pre prevádzku v súkromí a v bežnom kancelárskom prostredí.

Na základe kapacity skartácie uvedenej v technických údajoch platia nasledovné rámcové podmienky: Maximálny počet listov, ktoré je možné rezať naraz, v prípade dodržania nasledovných podmienok: Nové, resp. naolejované rezacie valce, studený motor, napájací prúd s menovitým napätím a menovitou frekvenciou (230V/50Hz, 120V/60Hz). Odchýlky môžu mať za následok zníženie kapacity skartácie a zvýšenie hlučnosti chodu. Listy sú vedené stredom a po dĺžke pod uhlom 90°. V závislosti od vlastností papiera a prívodu sa môže sa môže kapacita skartácie odlišovať.

1.2 Bezpečnostné pokyny

- Skontrolujte, či napätie a frekvencia v elektrickej sieti zodpovedá údajom na typovom štítku.
- Neinštalujte prístroj v blízkosti tepelného zdroja!
- Prístroj skladujte, prepravujte a prevádzkujte iba nastojato!
- Na prístroji používajte iba kvapaliny a plyny, ktoré zodpovedajú smerniciam spoločnosti DAHLE!
- Prístroj sa nesmie otvárať!
- Prístroj neprevádzkujte v chode naprázdno!
- Prístroj prevádzkujte iba v uzavretých priestoroch, pri 10 °C až 25 °C (50 °F do 77 °F) a nekondenzujúcej vlhkosti vzduchu od 15 % do 95 %!























- Zabezpečte ochranu pred skratom na inštalácii v budove: max. 16A (US max. 20A).
- Zavadzače papiera používajte iba jednotlivo!
- Prístroj nie je určený pre používanie osobami (vrátane detí) s obmedzenými fyzickými, zmyslovými alebo duševnými schopnosťami alebo nedostatočnými skúsenosťami a vedomosťami, jedine s výnimkou, ak pri používaní prístroja pracujú pod dozorom alebo výlučným vedením osoby, ktorá zodpovedá za bezpečnosť.



Skartovací prístroj zlikvidujte odborné a ekologicky na autorizovanom zbernom mieste. Žiadne časti skartovacieho prístroja alebo balenia nezhadzujte do domáceho odpadu.

1.3 Legenda piktogramov

	Dôležitá informácia		Nepoužívať v blízkosti horľavých kvapalín alebo plynov.		Pred skartovaním odstráňte z dokumentov kancelárske spinky a spony!
	Prečítajte si informáciu pre používateľa/bezpečnostné pokyny		Automatický rozbeh		Nezasúvajte žiadne disky!
	POZOR		Nevystavujte vlhkosti		Skartuje CD/DVD iba s nasadenými ochrannými okuliarmi!
	POZOR! Nebezpečenstvo úrazu elektrickým prúdom.		Tento skartovací prístroj nie je určený na používanie deťmi (výrobok nie je hračka).		Pred údržbárskymi prácami odpojte skartovací prístroj od napájacieho prúdu!
	POZOR, pohyblivé časti		Otvoru prívodu papiera sa nedotýkajte rukami!		Technické údaje — Technické zmeny vyhradené!
	POZOR, ostré hrany		Otvoru prívodu papiera sa nedotýkajte odevom!		Prevádzková hlasitosť pri chode naprázdno
	Nepoužívať v blízkosti žieravých látok.		Otvoru prívodu papiera sa nedotýkajte vlasmi!		Rýchlosť vťahovania
	Prístroj stabilne nainštalujte na podlahu a vo vzdialenosti 100 mm od steny, zabráňte hromadeniu tepla, Stlačte ručné brzdy (v závislosti od typu)		Do blízkosti neukladajte plechovky so sprejmi!		Prúžkový rez papiera

	Priečny rez papiera		Úroveň zabezpečenia - O Zničenie CD, DVD		Pri dlhšej prevádzke a/ alebo preťažení sa skartov- ovací prístroj automaticky vypne, aby vychladol.
	Prúžkový rez CD/DVD		Úroveň zabezpečenia - T Zničenie karty		Pokyny na údržbu/odstra- ňovanie porúch
	Priečny rez CD/DVD		Úroveň zabezpečenia - E Zničenie čipovej karty		Nádoba je plná
	Prúžkový rez karty		Obsluha		Možné poruchy
	Priečny rez karty		Skartovací prístroj v poho- tovostnom stave		automatické vypnutie pri otvorenom kryte
	Úroveň zabezpečenia - P Skartovanie papiera		Skartovací prístroj v pre- vádzke		Prehriatie
	Úroveň zabezpečenia - F Zničenie mikrofilmu		Automatické vypnutie!		Prehriatie



pl Instrukcja użytkownika



UWAGA!

PRZED uruchomieniem niszczarki należy uważnie przeczytać instrukcję obsługi oraz wskazówki bezpieczeństwa.



Należy przestrzegać wskazówek! Instrukcję obsługi należy zachować do późniejszego użytku.

Spis treści

1	Ważne informacje.....	64
1.1	Użytkowanie zgodne z przeznaczeniem, gwarancja.....	64
1.2	Wskazówki bezpieczeństwa.....	64
1.3	Objaśnienie symboli.....	65
1.4	Zakres dostawy.....	88
1.5	Dane techniczne.....	88
2	Obsługa.....	89
2.1	Zdejmowanie blokady transportowej.....	89
2.2	Podłączanie urządzenia do sieci elektrycznej.....	90
2.4	Włączanie urządzenia.....	90
2.5	Niszczanie dokumentów.....	91
2.8	Tryb ciągły.....	92
2.9	Niszczanie CD/DVD i kart.....	93
3	Konserwacja/usuwanie usterek.....	95
3.1	Opróżnianie niszczarki.....	95
3.3	Otwarty pojemnik.....	95
3.4	Przegrzanie.....	96
3.6	Zakleszczenie papieru.....	96
3.7	Czyszczenie urządzenia.....	97
3.9	Naoliwić urządzenie.....	98

1.1 Użytkowanie zgodne z przeznaczeniem, gwarancja

Niszczarka jest przeznaczona do niszczenia papieru. W zależności od modelu niszczarki można ją ponadto wykorzystać do niszczenia w niewielkich ilościach następujących materiałów:

- płyt CD/DVD, kart bankomatowych i kredytowych (patrz dane techniczne).
- występujących w zwykłym zakresie w dokumentach papierowych zszywek i spinaczy biurowych (wyjątek: urządzenia stopnia bezpieczeństwa P6 i P7).

Zużycie, szkody na skutek nieprawidłowego użycia oraz ingerencji osób trzecich nie są objęte ani rękojmią ani gwarancją.

Ta niszczarka dokumentów jest przeznaczona do użytku prywatnego oraz w normalnych warunkach biurowych.

Wydajność niszczarki podana w danych technicznych podlega następującym warunkom ogólnym: Maksymalna ilość kartek, która może zostać zniszczona w jednej turze w następujących warunkach: Nowe, ewentualnie naoliwione walce tnące, zimny silnik, zasilanie elektryczne z napięciem znamionowym i częstotliwością znamionową (30V/50Hz; 120V/60 Hz). Odstępstwa mogą prowadzić do zmniejszonej wydajności i do głośniejszej pracy. Kartki należy wkładać na środku, wzdłuż, pod kątem 90°. Wydajność może być zmienna również zależnie od rodzaju papieru i sposobu wprowadzania go.

1.2 Wskazówki bezpieczeństwa

- Sprawdzić, czy napięcie i częstotliwość sieci zgadzają się z danymi na tabliczce znamionowej.
- Urządzenia nie ustawiać w pobliżu źródeł ciepła!
- Urządzenie składować, transportować i użytkować wyłącznie w pozycji pionowej!
- W urządzeniu stosować wyłącznie ciecze i gazy spełniające wytyczne DAHLE!
- Urządzenia nie wolno otwierać!
- Nie użytkować urządzenia na pusto!
- Urządzenie wolno użytkować wyłącznie w zamkniętych pomieszczeniach w temperaturze od 10°C do

25 °C (50 °F do 77 °F) oraz przy nieskrapającym się powietrzu o wilgotności od 15 % do 95 %!

- Należy zapewnić zabezpieczenie przeciwzwarciowe w instalacji budynku: maks. 16 A (US maks. 20 A).
- Z podajników korzystać tylko pojedynczo!
- To urządzenie nie jest przeznaczone do użytku przez osoby (wraz dziećmi) z ograniczonymi zdolnościami fizycznymi, sensorycznymi lub umysłowymi lub z brakiącym doświadczeniem i wiedzą. Chyba, że pracują one pod nadzorem i otrzymują pełne instrukcje odno-

śnie korzystania z urządzenia od osoby odpowiedzialnej za bezpieczeństwo.



Niszczarkę usunąć w sposób nieszkodliwy dla środowiska przekazując do autoryzowanego punktu zbiórki. Żadnych elementów niszczarki lub jej opakowania nie wolno wyrzucać wraz z odpadami z gospodarstw domowych.

1.3 Objasnienie symboli

	Ważne informacje		Urządzenia nie wolno użytkować w pobliżu palnych cieczy lub gazów.		Nie wkładać dyskietek!
	Przeczytać informacje dla użytkownika/wskazówki bezpieczeństwa		Automatyczny rozruch		Podczas niszczenia nośników CD/DVD należy nosić okulary ochronne!
	UWAGA		Chronić urządzenie przed wilgocią		Przed przystąpieniem do prac konserwacyjnych odłączyć niszczarkę od zasilania!
	UWAGA! Ryzyko porażenia prądem.		Z niszczarki nie wolno korzystać dzieciom (produkt nie jest zabawką).		Dane techniczne - Zmiany techniczne zastrzeżone!
	UWAGA, części ruchome		Podajnika papieru nie wolno dotykać rękami!		Głośność pracy na pusto
	UWAGA, ostre krawędzie		Podajnika papieru nie wolno dotykać częściami garderoby!		Prędkość wciągania
	Urządzenia nie wolno użytkować w pobliżu substancji żrących		Podajnika papieru nie wolno dotykać włosami		Paski papieru
	Niszczarkę ustawić na stabilnym podłożu w odległości 100 mm od ściany, unikać zatorów ciepłych, uruchomić hamulec postojowy (w zależności od typu)		Trzymać z dala puszek ze sprayem!		Ścinki papieru
			Spinacze biurowe oraz zszywki usunąć przed przystąpieniem do niszczenia dokumentu!		Paski CD/DVD

1



Ścinki CD/DVD



Paski kart



Ścinki kart



Poziom bezpieczeństwa - P
niszczenie papieru



Poziom bezpieczeństwa - F
Zniszczenie mikrofilmów



Poziom bezpieczeństwa - O
Zniszczenie płyt CD, DVD



Poziom bezpieczeństwa - T
Zniszczenie karty



Poziom bezpieczeństwa - E
Zniszcz karty chipowe



Ciężar



Wtyczka sieciowa służy do
odłączania zasilania.



Gniazdo zasilania musi być
zawsze uziemione i łatwo
dostępne!



Obsługa



Niszczarka gotowa do pracy



Niszczarka pracuje



Automatyczne wyłączenie!



Niszczarka wyłącza się
automatycznie po dłuż-
szym czasie pracy i/lub w
razie przeciążenia w celu
ostygnięcia.



Wskazówki konserwacyjne
/ Usuwanie usterek



Pełny pojemnik



Możliwe zakłócenia



Automatyczne wyłączenie
w przypadku otwarcia
obudowy



Przegrzanie



Blokada silnika

ro Instrucțiuni de utilizare



ATENȚIE!

Înainte de punerea în funcțiune a distrugătorului de documente, citiți cu atenție instrucțiunile de utilizare și indicațiile privind siguranța!

Normele de siguranță trebuie aplicate!

Păstrați instrucțiunile pentru a le putea consulta ulterior.



Cuprins

1	Informații importante	67
1.1	Utilizarea conform destinației prevăzute, garanția standard	67
1.2	Indicații privind siguranța	67
1.3	Legenda pictogramelor	68
1.4	Pachetul de livrare.....	88
1.5	Date tehnice	88
2	Utilizare	89
2.1	Îndepărtarea dispozitivului de blocare a transportului	89
2.2	Conectați dispozitivul la rețeaua de curent	90
2.4	Cuplați dispozitivul.....	90
2.5	Distrugerea hârtiei	91
2.8	Mersul înainte continuu	92
2.9	Distrugerea de CD-uri/DVD-uri, carduri.....	93
3	Întreținerea/remedierea defecțiunilor	95
3.1	Evacuarea materialului tocat	95
3.3	Decipientului/capacului deschis	95
3.4	Supraîncălzirea	96
3.6	Blocaj de hârtie	96
3.7	Curățarea dispozitivului	97
3.9	Ungeți dispozitivul	98

1.1 Utilizarea conform destinației prevăzute, garanția standard

Distrugătorul de documente este conceput pentru distrugerea hârtiei.

În funcție de model, în afară de hârtie pot fi distruse și alte materiale în cantitate redusă, cum ar fi:

- CD-uri/DVD-uri, cecuri și carduri bancare (consultați secțiunea Date tehnice).
- clemele de capsator și agrafele de birou care se află în documente, în cantitate uzuală (excepție: aparatele din clasa de siguranță P6 și P7).

Uzura și deteriorările cauzate de utilizarea neadecvată și de intervențiile terților asupra dispozitivului nu fac obiectul garanției standard sau al garanției extinse.

Distrugătorul de documente este conceput pentru utilizarea în zona privată și în mediile de birou obișnuite.

Cu privire la numărul de coli specificat în datele tehnice se aplică următoarele condiții generale:

Numărul maxim de coli tăiate într-o singură fază poate fi asigurat în următoarele condiții: Rotoare de tăiere noi sau lubrificate recent, motor rece, alimentare cu curent electric cu tensiune nominală și frecvență nominală de (230V/50Hz, 120V/60 Hz). Eventualele abateri de la acești parametri pot duce la o performanță mai scăzută față de numărul de coli specificat și la un nivel de zgomot în funcționare mai ridicat. Colile trebuie să fie introduse central și longitudinal, în unghi de 90°. De asemenea, performanța privind numărul de coli poate fi influențată și de proprietățile hârtiei și de modul în care se face alimentarea cu materiale.

1.2 Indicații privind siguranța

- Verificați dacă tensiunea și frecvența rețelei de alimentare cu curent corespund cu datele de pe plăcuța cu caracteristici a dispozitivului.
- Nu amplasați dispozitivul în apropierea unei surse de căldură!
- Depozitați, transportați și utilizați dispozitivul numai în poziție verticală!
- Utilizați pentru distrugătorul de documente numai lichide și gaze conforme cu reglementările DAHLE!



- Dispozitivul nu trebuie deschis!
- Utilizarea dispozitivului este permisă numai în spații închise, la temperaturi cuprinse între 10 °C și 25 °C (50 °F și 77 °F) și la o umiditate atmosferică fără condensare cuprinsă între 15% și 95%!
- Protecția la scurtcircuit a instalației electrice a clădirii trebuie să fie asigurată: max. 16A(SUA max. 20A).
- Nu lăsați distrugătorul de documente să funcționeze în gol!
- Aparatul nu este conceput pentru a fi utilizat de persoane (inclusiv copiii) cu capacități fizice, senzoriale























sau mentale limitate ori cu experiență și cunoștințe reduse, cu excepția situațiilor în care lucrează sub supraveghere sau sunt îndrumate în permanență în utilizarea aparatului de către o persoană care răspunde pentru siguranță.



Eliminați distrugătorul de documente în mod corect și ecologic, la un centru autorizat de colectare a deșeurilor. Nu aruncați componente ale distrugătorului de documente sau ale ambalajului la gunoiul menajer.

1.3 Legenda pictogramelor

	Informație importantă		A nu se utiliza în apropierea lichidelor și a gazelor inflamabile.		Îndepărtați capsele și clemele de hârtie înainte de distrugerea documentelor!
	Consultați informațiile pentru utilizatori/instrucțiunile privind siguranța		Pornire automată		Nu introduceți dischete!
	Atenție		A nu se expune la umezeală		Purtați ochelari de protecție când distrugeți CD-uri/DVD-uri!
	ATENȚIE! Pericol de electrocutare.		Distrugătorul de documente nu este conceput pentru a fi utilizat de copii (produsul nu este un obiect de joacă).		Înainte de executarea lucrărilor de întreținere, deconectați dispozitivul de la alimentarea cu curent!
	ATENȚIE, piese mobile				Date tehnice - Rezervat dreptul de a efectua modificări tehnice!
	ATENȚIE, muchii ascuțite		Nu atingeți fanta pentru intrarea hârtiei cu mâinile.		Nivelul de zgomot la funcționarea în gol
	A nu se utiliza în apropierea substanțelor corozive.		Nu atingeți fanta pentru intrarea hârtiei cu obiecte de îmbrăcăminte!		Viteză de tragere în interior
	Amplasați dispozitivul în poziție stabilă la nivelul solului și la o distanță de 100 mm față de perete, evitați acumularea de căldură, Acționarea frânelor de blocare (în funcție de tip)		Nu atingeți fanta pentru intrarea hârtiei cu părul!		Tăierea în fâșii a hârtiei
			Țineți la distanță tuburile de spray!		Tăierea în particule a hârtiei

- | | | | | | |
|--|---|---|---|---|--|
|  | Tăierea în fâșii a CD-urilor/
DVD-urilor |  | Poziom bezpieczeñstwa - F
Zniszcz karty chipowe |  | În cazul unei funcționări
mai îndelungate și/sau în
caz de suprasarcină, dis-
trugătorul de documente
se oprește automat în scop
de răcire. |
|  | Tăierea în particule a
CD-urilor/DVD-urilor |  | Greutate |  | Instrucțiuni pentru lucrări
de întreținere / remedierea
defecțiunilor |
|  | Tăierea în fâșii a cardurilor |  | Ștecherul servește ca dis-
pozitiv de deconectare de
la alimentarea cu curent
electric! |  | Recipient plin |
|  | Tăierea în particule a car-
durilor |  | Priza de alimentare cu
curent electric, cu împă-
mântare, trebuie să fie
accesibilă în orice moment! |  | Avarii posibile |
|  | Poziom bezpieczeñstwa - P
Niszczenie papieru |  | Utilizare |  | Aparatul se oprește auto-
mat atunci când este
deschis |
|  | Poziom bezpieczeñstwa - F
Zniszczenie mikrofilmów |  | Distrugetorul de documen-
te pregătit de funcționare |  | Supraîncălzirea |
|  | Poziom bezpieczeñstwa - O
Zniszczenie płyt CD, DVD |  | Distrugetorul de documen-
te în funcțiune |  | Blocare motor |
|  | Poziom bezpieczeñstwa - T
Zniszczenie karty |  | Oprire automată! | | |

**bg** Указание за употреба**ВНИМАНИЕ!**

ПРЕДИ пускане в експлоатация на машината за унищожаване на документи, прочетете ръководството за употреба и препоръките за безопасност.

Указанията трябва да се прилагат! Съхранявайте ръководството за бъдеща употреба.

**Съдържание**

1	Важна информация	70
1.1	Използване по предназначение, гаранция	70
1.2	Указания за безопасност	71
1.3	Легенда на пиктограмите	71
1.4	Окомплектовка на доставката	88
1.5	Технически данни	88
2	Обслужване	89
2.1	Премахване на транспортната ключалка	89
2.2	Свързване на уреда към електрическата мрежа	90
2.4	Включване на уреда	90
2.5	Унищожаване на хартия	91
2.8	Непрекъснат ход	92
2.9	Унищожаване на CD/DVD, карти	93
3	Поддръжка/отстраняване на неизправности	95
3.1	Изпразване на изрезките	95
3.3	Отворен контейнер	95
3.4	Прегряване	96
3.6	Засядане на хартия	96
3.7	Почистване на уреда	97
3.9	Намажете устройството с масло	98

1.1 Използване по предназначение, гаранция

Машината за унищожаване на документи е предназначена за унищожаване на хартия.

В зависимост от варианта на модела, освен това могат да се унищожават минимални количества от следните материали:

- CD/DVD, платежни и кредитни карти (виж Технически данни).
- телчета и кламери в количеството, обичайно за приложението им в хартиени документи (изключение: уреди с ниво на сигурност P6 и P7).

Износване, повреди поради некомпетентна употреба, както и намеси на трети лица, не попадат под гаранцията.

Машината за унищожаване на документи е разработена за частна употреба и нормална офис среда.

По отношение на посочената в техническите данни производителност в листове важат следните рамкови условия:

Максимален брой листове, които се режат при едно преминаване при следните условия: Нови, респ. смазани режещи валащи, студен двигател, електрозахранване с номинално напрежение и номинална честота (230 V/50 Hz; 120 V/60 Hz). Отклоненията може да доведат до по-ниска производителност в листове и до увеличени шумове при рязане. Листите се подават в средата и надлъжно под 90°. В зависимост от характеристиките на хартията и подаването е възможно производителността в листи също да варира.

1.2 Указания за безопасност

- Проверете дали напрежението и мрежовата честота на Вашата електрозахранваща мрежа съответстват на данните на типовата табелка.
- Указания за безопасност
- Уредът да не се поставя в близост до източник на топлина!
- Уредът да се складира, транспортира и експлоатира само в изправено положение!
- В уреда да се използват само течности и газове, които съответстват на директивите на DAHLE!
- Не се допуска отварянето на уреда!
- Уредът да се експлоатира само в затворени помещения, при 10°C до 25°C (50°F до 77°F) и некондензираща въздушна влажност от 15% до 95%!
- Трябва да се гарантира безопасността на инсталацията на сградата при късо съединение: макс. 16А (САЩ макс. 20А).
- Уредът да не се експлоатира на празен ход!
- Уредът не е предназначен за използване от лица (включително деца) с ограничени психични, сетивни или умствени способности или недостатъчен опит и знания, освен ако работят под надзор или са получили подробен инструктаж за използването на уреда от лице, което отговаря за безопасността.



Изхвърляйте машината за унищожаване на документи компетентно и екологично в оторизиран събирателен пункт. Не изхвърляйте части от машината за унищожаване на документи или от опаковката с битовата смет.

1.3 Легенда на пиктограмите

- | | | | | | |
|--|--|--|--|--|--|
| | Важни информации | | Уредът да се постави стабилно на пода и на разстояние от 100 mm от стената, да се избягва акумулиране на топлина, Задействане на застопоряващите спирачки (в зависимост от типа) | | Не докосвайте с ръце подаването на хартията. |
| | Да се прочете информацията за потребителя/препоръките за безопасност | | Да не се използва в близост до горими течности или газове. | | Не докосвайте с части от облеклото подаването на хартията! |
| | ВНИМАНИЕ | | Автоматично пускане | | Не докосвайте с косите подаването на хартията! |
| | ВНИМАНИЕ! Риск от токов удар. | | Да не се излага на влага | | Дръжте далеч флакони със спрей! |
| | ВНИМАНИЕ, движещи се части | | Тази машина за унищожаване на документи не е предназначена за използване от деца (продуктът не е играчка). | | Кламерите да се отстраняват преди процеса на унищожаване! |
| | ВНИМАНИЕ, остри ръбове | | | | Не вкарвайте дискети! |
| | Да не се използва в близост до разяждащи вещества. | | | | При унищожаване на CD/DVD носете защитни очила! |



Преди работи по поддръжката, машината за унищожаване на документи да се изключи от електрозахранването!



Технически данни - запазено правото за технически промени!



Работен шум на празен ход



Скорост на поемане



Рязане на хартията на ивици



Рязане на хартията на частици



Рязане на CD/DVD на ивици



Рязане на CD/DVD на частици



Рязане на карти на ивици



Рязане на карти на частици



ниво на сигурност - P
раздробяване на хартията



ниво на сигурност - F
унищожаване на микрофилм



ниво на сигурност - O
Унищожаване на CD, DVD



ниво на сигурност - T
унищожаване на картата



ниво на сигурност - E
унищожаване на чип карта



Тегло



Мрежовият контакт със защитно заземяване трябва по всяко време да е лесно достъпен!



Мрежовият контакт трябва по всяко време да е лесно достъпен!



Употреба



Машина за унищожаване на документи в готовност



Машина за унищожаване на документи при работа



Автоматично изключване!



При по-дълга експлоатация и/или претоварване, машината за унищожаване на документи се изключва автоматично за охлаждане.



Указания за поддръжка / отстраняване на неизправности



Контейнер пълен



Възможни неизправности



автоматично изключване при отворен корпус



Прегряване



Блокаж на двигателя

tr Kullanım kılavuzu



DİKKAT!

Dosya yok edicisini çalıştırmadan ÖNCE kullanım kılavuzunu ve güvenlik uyarılarını dikkatle okuyun.



Uyarılar uygulanmalıdır!
Kullanım kılavuzunu bir başvuru kaynağı olarak dikkatle muhafaza edin.

İçindekiler

1	Önemli Bilgiler	73
1.1	Amacına Uygun Kullanım, Garanti	73
1.2	Güvenlik Uyarıları	73
1.3	Piktogram Açıklaması	74
1.4	Teslimat Kapsamı	88
1.5	Teknik Veriler	88
2	Kullanım	89
2.1	Taşıma kilidinin çıkarılması	89
2.2	Cihazı Güç Kaynağına Bağlama	90
2.4	Cihazı Çalıştırma	90
2.5	Kağıt İmhası	91
2.8	Sürekli Besleme	92
2.9	CD/DVD, Kart İmhası	93
3	Bakım / Arıza Giderme	95
3.1	Kesilen Atıkları Boşaltma	95
3.3	Hazne/Kapak Açık	95
3.4	Aşırı Isınma	96
3.6	Kağıt sıkışması	96
3.7	Cihazı Temizleme	97
3.9	Cihazı yağlayın	98

1.1 Amacına uygun kullanım, garanti

Dosya yok edicisi kağıtların imha edilmesi için tasarlanmıştır.

Model türüne göre ayrıca aşağıdaki maddelerden az miktarda imha edilebilir:

- CD'ler/DVD'ler, çek ve kredi kartları (Teknik Verilere bakın).
- kağıt dokümanlarda, normal kapsamda mevcut ataçlar (İstisna: P6 ve P7 emniyet kademesi cihazlar).

Aşınma, amacının dışında kullanım sonucu oluşan hasarlar ve üçüncü şahısların müdahaleleri garanti kapsamına girmezler

Dosya yok edicisi kişisel kullanım ve normal büro ortamı için tasarlanmıştır.

Teknik bilgiler doğrultusunda belirtilen sayfa performansı ile ilgili olarak aşağıdaki çerçeve koşullar geçerlidir:

Bir geçişte aşağıdaki koşullar altında kesilen maksimum sayfa sayısı: Yeni, gerekirse yağlanmış kesme merdaneleri, soğuk motor, nominal gerilimi ve nominal frekansı ile elektrik beslemesi (230V/50 Hz; 120V/60 Hz). Sapmalar daha düşük bir sayfa performansına ve daha yüksek çalışma gürültüsüne yol açabilir. Sayfalar ortalananak ve uzunlamasına 90°'lik açıyla beslenir. Kağıt özelliklerine ve beslemeye göre sayfa performansı değişebilir.

1.2 Güvenlik uyarıları

- Kullandığınız şebeke elektriğinin voltajının ve frekansının tip plakasındaki bilgilerle aynı olmasını kontrol edin.
- Cihazı, ısı kaynağının yakınına monte etmeyin!
- Cihazı sadece dik şekilde depolayın, taşıyın ve çalıştırın!
- Cihazda yalnızca DAHLE yönergelerine uygun sıvılar ve gazlar kullanın!
- Cihaz açılmamalıdır!
- Cihazı sadece kapalı mekanlarda, 10 C ile 25 C (50 °F - 77 °F) arasındaki sıcaklıklarda %15 ile %95 arasındaki yoğunlaşmayan hava nemliliğinde çalıştırın!
- Bina tesisatının kısa devre yapmaması sağlanmalıdır: maks. 16A (US maks. 20A).
- Cihazı boşta çalıştırmayın!

- Cihaz fiziksel, sensörel veya ruhsal yetenekleri sınırlı veya yeterli deneyime ve bilgiye sahip olmayan kişiler (çocuklar dahil) tarafından kullanılmamalıdır. Buna sadece gözetim altında oldukları zaman veya güvenliğinden sorumlu bir kişi tarafından cihazın kullanımını ayrıntılı olarak anlatılırsa izin verilir.



Dosya yok edicisini teknolojiye ve çevreye uygun bir şekilde yetkili bir toplama yerinde imha edin. Dosya yok edicisinin parçalarını veya ambalajını ev çöpmeye atmayın.

1.3 Piktogram açıklaması



Önemli bilgi



Kullanıcı bilgisi/güvenlik uyarılarını okuyun



DİKKAT



DİKKAT! Elektrik çarpması riski.



DİKKAT, hareketli parçalar



DİKKAT, keskin kenarlar



Aşındırıcı maddelerin yakınında kullanmayın.



Cihazı güvenli duracak şekilde ve duvara 100 mm mesafede kurun, ısı birikmesini önleyin, Sabitleme frenlerini devreye alın (tipe bağlı)



Yanıcı sıvıların ve gazların yakınında kullanmayın.



Otomatik çalışma



Islaklığa maruz bırakmayın



Bu dosya yok edicisi çocuklar tarafından kullanılmak üzere tasarlanmamıştır (ürün, oyuncak değildir).



Kağıt beslemesine ellerinizle dokunmayın.



Kağıt beslemesine elbise/elleriniz değmemelidir!



Kağıt beslemesine saçlarınızla dokunmayın!



Sprey kutularını uzak tutun!



Yok etmeden önce kısıpçaları ve ataçları çıkarın!



Disket yerleştirmeyin!



CD/DVD'yi imha ederken koruyucu gözlük takılmamalıdır!



Bakım çalışmalarından önce dosya yok edicisini elektrik beslemesinden ayırın!



Teknik veriler - Teknik değişiklik yapma hakkı saklıdır!



Boşta çalışırken çalışma sesi



Çekme hızı



Kağıt şerit kesim



Kağıt partikül kesim



CD/DVD şerit kesim



CD/DVD partikül kesim



Kart şerit kesim



Kart partikül kesim



Güvenlik seviyesi - P
kağıt parçalama



Güvenlik seviyesi - F
mikrofilm yıkımı



Güvenlik seviyesi - O
CD, DVD imhası



Güvenlik seviyesi - T
kart imhası



Güvenlik seviyesi - E
Çipli kartları yok et



Ağırlık



Fiş, elektrik kaynağından
ayırma tertibatı olarak
kullanılır.



Koruyucu topraklı elektrik
prizi her zaman kolayca
erişilebilir olmalıdır!



Kullanım



Dosya yok edicisi hazır



Dosya yok edicisi çalışıyor



Otomatik kapatma!



Uzun süreli işletimde ve/
veya aşırı yüklenme duru-
munda dosya yok edicisi
otomatik olarak soğumak
için kapanır.



Bakım bilgileri/arıza gider-
me



Hazne dolu



Olası arızalar



Gövde açık iken otomatik
kapanma



Aşırı ısınma



Motor blokaj

eI Οδηγίες χρήσης



ΠΡΟΣΟΧΗ!

ΠΡΙΝ από την έναρξη λειτουργίας του καταστροφέα εγγράφων διαβάξτε προσεκτικά το εγχειρίδιο χρήσης και τις υποδείξεις ασφαλείας.

Πρέπει να τηρούνται οι υποδείξεις!

Το εγχειρίδιο χρήσης πρέπει να φυλάσσεται για μεταγενέστερη χρήση.



Πίνακας περιεχομένων

1	Σημαντικές πληροφορίες	76
1.1	Ενδεδειγμένη χρήση, παροχές εγγύησης	76
1.2	Υποδείξεις ασφαλείας	77
1.3	Λεζάντες εικονογραμμάτων	77
1.4	Παραδοτέα	88
1.5	Τεχνικά στοιχεία	88
2	Χειρισμός	89
2.1	Αφαίρεση της κλειδαριάς μεταφοράς	89
2.2	Σύνδεση της συσκευής στο δίκτυο ρεύματος	90
2.4	Ενεργοποίηση συσκευής	90
2.5	Καταστροφή χαρτιού	91
2.8	Συνεχόμενη πρόωθηση	92
2.9	Καταστροφή CD/DVD, καρτών	93
3	Συντήρηση/Αντιμετώπιση βλαβών	95
3.1	Άδειαση προϊόντων κοπής	95
3.3	Δοχείο/καπάκι ανοιχτό	95
3.4	Υπερθέρμανση	96
3.6	Συσώρευση χαρτιού χειροκίνητης εισαγωγής	96
3.7	Καθαρισμός συσκευής	97
3.9	Λιπάνετε τη συσκευή	98

1.1 Ενδεδειγμένη χρήση, παροχές εγγύησης

Ο καταστροφέας εγγράφων προορίζεται για την καταστροφή χαρτιών.

Ανάλογα με την έκδοση του μοντέλου, καταστρέφει επίσης και τα παρακάτω υλικά σε μικρές ποσότητες:

- CD/DVD, χρωστικές και πιστωτικές κάρτες (βλέπε Τεχνικά Στοιχεία).
- συνδετήρες και σύρματα συρραπτικών στις συνηθισμένες ποσότητες που χρησιμοποιούνται σε έγγραφα (εξαιρέση: συσκευές της κατηγορίας ασφαλείας P6 και P7).

Η φθορά, οι ζημιές από ακατάλληλη χρήση καθώς και οι επεμβάσεις από τρίτους δεν περιλαμβάνονται στις παροχές της εγγύησης ούτε καλύπτονται από εγγύηση.

Ο καταστροφέας εγγράφων έχει σχεδιαστεί για ιδιωτική χρήση και κανονικές συνθήκες γραφείου.

Σχετικά με την απόδοση σε φύλλα που αναφέρεται στα παρακάτω τεχνικά στοιχεία ισχύουν οι ακόλουθες προϋποθέσεις πλαισίου:

Μέγιστο πλήθος φύλλων, που κόβεται σε μία διέλευση υπό τις ακόλουθες προϋποθέσεις: Καινούργιοι ενδεχ. λιπασμένοι κύλινδροι κοπής, ψυχρός κινητήρας, τροφοδοσία ρεύματος με ονομαστική τάση και ονομαστική συχνότητα (230 V/50 Hz, 120 V/60 Hz). Τυχόν αποκλίσεις μπορεί να οδηγήσουν σε μειωμένη απόδοση σε φύλλα και σε αυξημένους θορύβους λειτουργίας. Τα φύλλα τροφοδοτούνται κεντρικά και κατά μήκος κάτω από 90°. Ανάλογα με τις ιδιότητες του χαρτιού και την τροφοδοσία, η απόδοση σε φύλλα μπορεί και να διαφέρει.

1.2 Υποδείξεις ασφαλείας

- Ελέγξτε αν η τάση και η συχνότητα του δικτύου ρεύματος συμφωνούν με τα στοιχεία στην πινακίδα τύπου.
- Υποδείξεις ασφαλείας
- Η συσκευή δεν επιτρέπεται να τοποθετείται κοντά σε πηγές θερμότητας!
- Αποθηκεύετε, μεταφέρετε και λειτουργείτε τη συσκευή μόνο σε όρθια θέση!
- Χρησιμοποιείτε στη συσκευή μόνο υγρά και αέρια που πληρούν τις οδηγίες DAHLE!
- Η συσκευή δεν επιτρέπεται να ανοίγεται!
- Η λειτουργία της συσκευής επιτρέπεται μόνο σε κλειστούς χώρους, με θερμοκρασία από 10°C έως 25°C (50°F έως 77°F) και μη συμπυκνούμενη υγρασία αέρα από 15% έως 95%!
- Πρέπει να διασφαλίζεται η ασφάλεια βραχυκυκλώματος της κτιριακής εγκατάστασης: έως 16 A (Η.Π.Α. έως 20 A).
- Η συσκευή δεν πρέπει να λειτουργεί άδεια!
- Η συσκευή δεν προορίζεται για χρήση από άτομα (συμπεριλαμβανομένων παιδιών) με περιορισμένες φυσικές, αισθητηριακές ή πνευματικές ικανότητες ή ελλιπή εμπειρία και γνώσεις, εκτός αν εργάζονται υπό επίτηρηση ή έχουν λάβει λεπτομερείς οδηγίες σχετικά με τη χρήση της συσκευής από άτομο υπεύθυνο για την ασφάλεια.



Ο καταστροφέας εγγράφων πρέπει να απορρίπτεται σωστά και με περιβαλλοντικά ορθό τρόπο σε εξουσιοδοτημένο κέντρο συλλογής. Μην ρίχνετε μέρη του καταστροφέα εγγράφων ή της συσκευασίας στα οικιακά απορρίμματα.

1.3 Λεζάντες εικονογραμμάτων



Σημαντική πληροφορία



Διαβάστε τις πληροφορίες χρήστη και τις υποδείξεις ασφαλείας



ΠΡΟΣΟΧΗ



ΠΡΟΣΟΧΗ! Κίνδυνος ηλεκτροπληξίας.



ΠΡΟΣΟΧΗ, κινούμενα μέρη



ΠΡΟΣΟΧΗ, αιχμηρές άκρες



Δεν επιτρέπεται η χρήση κοντά σε διαβρωτικά υλικά.



Η συσκευή πρέπει να τοποθετείται με στατική ασφάλεια στο δάπεδο, σε απόσταση 100 mm από τον τοίχο και να αποφεύγεται η συσσώρευση θερμότητας. Να χρησιμοποιούνται τα φρένα ακινητοποίησης (ανάλογα με τον τύπο)



Δεν επιτρέπεται η χρήση κοντά σε εύφλεκτα υγρά ή αέρια.



Αυτόματη εκκίνηση λειτουργίας



Δεν επιτρέπεται η έκθεση σε υγρασία



Αυτός ο καταστροφέας εγγράφων δεν προορίζεται για χρήση από παιδιά (το προϊόν δεν είναι παιχνίδι).



Μην αγγίζετε με τα χέρια την τροφοδοσία χαρτιού.



Μην αγγίζετε με μέρη της ενδυμασίας την τροφοδοσία χαρτιού!



Τα μαλλιά σας δεν πρέπει να αγγίζουν την τροφοδοσία χαρτιού!



Κρατάτε μακριά τυχόν δοχεία ψεκασμού!



Οι συνδεδητές γραφείου και συρραπτικών πρέπει να αφαιρούνται πριν από τη διαδικασία καταστροφής!



Μην εισάγετε δισκέτες!



Κατά την καταστροφή CD/DVD να φοράτε προστατευτικά γυαλιά!



Πριν από εργασίες συντήρησης αποσυνδέετε τον καταστροφέα εγγράφων από την τροφοδοσία ρεύματος!



Τεχνικά στοιχεία - Με την επιφύλαξη του δικαιώματος τεχνικών αλλαγών!



Ένταση ήχου σε άδεια λειτουργία



Ταχύτητα εισαγωγής



Κοπή χαρτιού σε λωρίδες



Κοπή χαρτιού σε τεμάχια



Κοπή CD/DVD σε λωρίδες



Κοπή CD/DVD σε τεμάχια



Κοπή καρτών σε λωρίδες



Κοπή καρτών σε τεμάχια



επίπεδο ασφαλείας - P τεμαχισμός χαρτιού



επίπεδο ασφαλείας - F καταστροφή μικροφίλμ



επίπεδο ασφαλείας - O Καταστροφή CD, DVD



επίπεδο ασφαλείας - T καταστροφή κάρτας



επίπεδο ασφαλείας - E καταστροφή καρτών τσιπ



Βάρος



Το φις δικτύου ρεύματος χρησιμεύει ως διάταξη αποσύνδεσης της τροφοδοσίας ρεύματος.



Η γειωμένη πρίζα πρέπει να είναι εύκολα προσβάσιμη ανά πάσα στιγμή!



Χειρισμός



Καταστροφές εγγράφων σε λειτουργική ετοιμότητα



Καταστροφές εγγράφων σε λειτουργία



Αυτόματη απενεργοποίηση!



Κατά την παρατεταμένη λειτουργία και/ή υπερφόρτωση ο καταστροφές εγγράφων μεταβαίνει αυτόματα σε λειτουργία ψύξης.



Υποδείξεις συντήρησης / Αντιμετώπιση βλαβών



Κάδος γεμάτος



Πιθανές διαταραχές



Αυτόματη απενεργοποίηση με ανοιχτό περίβλημα



Υπερθέρμανση



Μπλοκάρισμα κινητήρα



انتبه!
قم بقراءة دليل الاستعمال وتعليمات الأمان بعناية قبل بدء تشغيل ماكينة تقطيع الورق. لا بد من تطبيق هذه التعليمات. احتفظ بدليل الاستعمال لاستخدامه لاحقاً.

ماكينة فرم المستندات مخصصة لإتلاف الورق. تبعاً لنوع الموديل يمكن أيضاً إتلاف كمية قليلة من المواد التالية:
- الأقراص المضغوطة / أقراص DVD وبطاقات صرف الشيكات وبطاقات الائتمان (انظر البيانات التقنية).
- دبابيس المكتب ومشابك الورق التقليدية الموجودة في الوثائق الورقية (باستثناء: الأجهزة بمستوى الأمان P6 و P7).

المحتويات

79	1	معلومات هامة
79	1.1	الاستخدام المطابق للتعليمات، الضمان
79	1.2	تعليمات السلامة
80	1.3	رموز الرسم التوضيحي
88	1.4	المحتويات المُوردة
88	1.5	المواصفات التقنية
89	2	الاستخدام
89	1.2	إزالة قفل النقل
90	2.2	توصيل الجهاز بأخذ التيار الكهربائي
90	2.4	تشغيل الجهاز
91	2.5	إتلاف الورق
92	2.8	التشغيل المستمر
	2.9	إتلاف الأقراص المضغوطة / أقراص الفيديو الرقمية، والبطاقات
93		
95	3	الصيانة / إزالة الأعطال
95	3.1	تفريغ القصاصات
95	3.3	الحاوية مفتوحة
96	3.4	ارتفاع في درجة الحرارة
96	3.6	انحشار ورقي
97	3.7	تنظيف الجهاز
98	3.9	قم بتشحيم الجهاز

فيما يتعلق بسعة الورق المنصوص عليها في البيانات التقنية تطبق الشروط العامة التالية:

الحد الأقصى لعدد الأوراق المقطوعة دفعة واحدة تحت الشروط التالية: إسطوانات قطع جديدة، ومزيتة إذا لزم الأمر، محرك بارد، وتغذية كهربية بجهد اسمي وتردد اسمي (٢٣٠ فولت / ٥٠ هرتز، ١٢٠ فولت / ٦٠ هرتز). الانحرافات يمكن أن تؤدي إلى انخفاض معدل سعة الورق وزيادة الضوضاء أثناء التشغيل. يتم تغذية الأوراق في المنتصف وبالطول في اتجاه ٩٠ درجة. قد تختلف سعة الورق أيضاً اعتماداً على خصائص الورق والتغذية.

1.2 تعليمات الأمان

- تحقق من توافق الجهد وتردد الطاقة بشبكة إمداد الطاقة لديك مع المعلومات الواردة على لوحة البيانات.
- لا تضع الماكينة بالقرب من مصدر حرارة!
- لا تُخزّن الماكينة ولا تُنقل ولا تُشغل إلا وهي قائمة في وضع رأسي!
- لا تُستخدم في الماكينة إلا السوائل والغازات التي تتفق مع توجيهات شركة DAHLE!
- لا تقم بفتح الماكينة!
- لا يجب تشغيل الجهاز في الأماكن المغلقة إلا ضمن درجات حرارة تتراوح ما بين ١٠ وحتى ٢٥ درجة مئوية (٥٠ إلى ٧٧ درجة فهرنهايت) وفي رطوبة غير مكثفة تتراوح ما بين ١٥٪ إلى ٩٥٪!
- يجب الحماية من قصر الدائرة بتكبيات البناء: الحد الأقصى ١٦ أمبير (٢٠ أمبير بحد أقصى في الولايات المتحدة).
- لا يتم تشغيل الماكينة على سرعة التباطؤ!
- الجهاز غير مخصص للاستخدام بواسطة أشخاص (هما في ذلك

الأطفال) ممن لديهم ضعف في القدرات الجسدية أو الحسية أو العقلية أو ممن لديهم نقص خبرة ومعرفة إلا تحت إشراف أو بتلقي تعليمات تفصيلية عن استخدام الجهاز من قِبَل شخص يكون مسئولاً عن السلامة.

تخلص من ماكينة تقطيع الورق بطريقة سليمة وصديقة للبيئة بإحدى نقاط التجميع المعتمدة. لا تضع أي جزء من أجزاء ماكينة تقطيع الورق أو تخلفها في القمامة المنزلية.



رموز الرسم التوضيحي 1.3

معلومات هامة		لا تُستخدم بالقرب من سوائل أو غازات سريعة الاشتعال.		عند تدمير CD / DVD ، يجب ارتداء نظارات السلامة!	
اقرأ معلومات المستخدم/ تعليمات الأمان		يتم التشغيل أوتوماتيكيًا		قبل القيام بأعمال الصيانة يجب فصل ماكينة تقطيع الورق عن إمداد الطاقة!	
تنبيه / احترس		لا تُعرض للبلل		البيانات التقنية - يُحتفظ بالحق في عمل تغييرات تقنية!	
انتباه! خطر حدوث صدمة كهربائية.		ماكينة تقطيع الورق هذه غير مخصصة لاستخدام الأطفال (لا يعتبر المنتج لعبة).		مستوى صوت التشغيل على سرعة التباطؤ	
تنبيه الأجزاء المتحركة		لا تلمس مغذي الورق بيديك.		سرعة التغذية	
تنبيه ، حواف حادة		لا تلمس مغذي الورق بقطع من الملابس.		تقطيع الورق على شكل أشرطة	
لا تُستخدم بالقرب من مواد كاوية.		لا تلمس مغذي الورق بيديك.		تقطيع الورق على شكل جزئيات صغيرة	
توضع ماكينة تقطيع الورق في وضع مستقر على الأرضية وعلى مسافة ١٠٠ ملم من الحائط∞ تجنب الحرارة المتخلفة.		أبعدها عن علب الرذاذ!		تقطيع الأقراص المضغوطة/ أقراص DVD على شكل أشرطة	
يُضغَط على فرامل التثبيت (متعلق بالنوع)		يجب إزالة مشابك ودبابيس الورق قبل إجراء عملية تقطيع الورق!		تقطيع الأقراص المضغوطة/ أقراص DVD على شكل جزئيات صغيرة	
		لا تقم بإدخال الأقراص!			

تقطيع البطاقات على شكل أشرطة		يستخدم قابس التيار كتجهيزة قطع لإمداد الطاقة.		عند التشغيل لفترات طويلة و/أو التحميل الزائد تفصل ماكينة قطع الأوراق أوتوماتيكيًا للتبريد.	
فقطع البطاقات البلاستيكية في شكل جزيئات صغيرة		يجب أن يكون المقبس الكهربائي الموصل عن طريق التأريض الوقائي في موضع يسهل الوصول إليه في أي وقت!		تعليمات الصيانة / إصلاح الأعطال	
مستوى الأمان - P تمزيق الورق		الاستعمال		الوعاء ممتلئ	
مستوى الأمان - F تدمير الميكروفيلم		ماكينة تقطيع الورق في وضع الاستعداد		حالات الخلل المحتملة	
مستوى الأمان - O تدمير CD و DVD		ماكينة تقطيع الورق قيد التشغيل		الفصل الأوتوماتيكي عند التشغيل عند فتح العلبة	
مستوى الأمان - T تدمير البطاقة		الفصل الأوتوماتيكي!		ارتفاع في درجة الحرارة	
مستوى الأمان - E تدمير البطاقة الذكية				تم حظر المحرك	
الوزن					



ja 取扱説明書



注意!

ご使用の前に、本製品の取扱説明書に記載されている使い方や安全上の注意をよくお読みください。



安全上の指示を必ず守ってご使用ください。取扱説明書はいつでも読めるように保管しておいてください

目次

1	重要事項	82
1.1	正しい使用法	
	製品の保証について	82
1.2	安全上の注意	83
1.3	ピクトグラムの説明	83
1.4	製品の内容	88
1.5	技術仕様	88
2	操作	89
2.1	輸送用ロックの取り外し	89
2.2	装置を電源に接続する	90
2.4	装置のスイッチを入れる	90
2.5	用紙の裁断	91
2.8	連続細断	92
2.9	CD/DVD、カードの裁断	93
3	メンテナンス / トラブルシューティング	95
3.1	ダストボックスを空にする	95
3.3	ゴミ箱が開いています	95
3.4	装置の過熱	96
3.6	紙詰まり	96
3.7	お手入れ方法	97
3.9	デバイスに油をさします	98

1.1 正しい使用法、製品の保証について

このシュレッダーは紙を細断するためにつくられています。機種によっては、次のものを少量ずつ細断できるタイプもございます:

- CD/DVD、キャッシュカード、クレジットカード (技術仕様をご確認ください)。
- 一般的な文書類に使用される、市販のホチキス(セキュリティレベルP6およびP7は除く)。

本機は折られていない用紙 (100g/m² 以下) の束をオートフィードで処理します。基本的には、クリップやホチキスで綴じた紙も裁断することが可能です。この場合は必ず用紙トレイの後方 (使用者と離れた場所) にホチキス等が来るように置いてください。ただし、本機の寿命を延ばすためにも、予めクリップやホチキスを取り外してご使用いただくことをお勧めします。ホチキス等の数と場所、および用紙の枚数によっては、紙送りエラーが生じて裁断処理が停止することがあります。

指示に従わなかったり、用途以外のものを投入したことで生じた故障や損害について、当社は一切の責任を負いません。また、これらの故障や損害は当社保証の対象外となります。

本シュレッダーは、個人使用および一般的な事務での使用向けに設計されています。技術仕様に記載の処理能力に応じて、以下の条件が適用されます。

一回に挿入できる枚数は、以下の条件で定義したものです。新品もしくはオイルを塗布したローラー、エンジン冷間状態、公称電圧および公称周波数 (230V/50Hz; 120V/60Hz) での電源供給。上記以外の条件で使用した場合は、挿入できる枚数が減ったり音が大きくなる場合があります。用紙は中央から縦方向に、90度以上曲げずに挿入。用紙の性質や入れ方によっては、処理内容に変化が生じる可能性があります。

1.2 安全に関するご注意































- ご使用電源の電圧および周波数が、本製品形式表示板の表記と一致することをご確認ください。
- 本機を熱源のそばに置かないでください。
- 本機は決して倒さず、縦にして保管や移動をしてください。
- ダーレ社の純正シュレッターオイル、ガス以外は使用しないでください。
- 本体を決して開けないでください。
- 本機は温度 10°C~25°C (50°F~77°F) の閉めきった部屋で使用してください。また、湿度は15%~95%以内を保ち、結露しないように注意してください。
- 建物の配線設備の短絡保護装置が正常に作動することをご確認ください (最大16 A、米国では20 A)。
- 本機を空回りさせないでください。
- 身体上の理由または知覚・精神上の理由から操作に困難を伴う方 (お子様も含む) や、装置の操作に関する経験と知識が不十分な方は、本機を単独でご使用にならないでください。上記の方が本機を扱う際は、安全面で責任を持てる方が付き添って操作し、操作について十分な指導を行うことが必須要件となります。



シュレッターを廃棄する際は分別方法および環境に配慮し、自治体の指示に従ってください。シュレッターのパーツや梱包材は、一般ゴミとして廃棄しないでください

1.3 ピクトグラムの説明

- | | | | | | |
|--|--------------------------------|--|--|--|----------------------------------|
| | 重要事項 | | 本機は床にしっかり安定させ、壁面から 100 mm 離して設置してください。また、本体内部が過熱しないよう注意し、必ずストッパーを使用してください (機種により異なる) | | 用紙投入口に服が巻き込まれないようご注意ください。 |
| | 取扱説明書/安全に関する注意事項をお読みください | | 可燃性の液体やガスの近くでは使わないでください。 | | 用紙投入口に髪の毛が巻き込まれないようご注意ください。 |
| | 注意 | | オートスタート | | スプレー缶を近づけないでください。 |
| | 注意! 感電の危険があります。 | | 湿度の高い場所に放置しないでください。 | | 用紙クリップやホチキスはシュレッターにかける前に外してください。 |
| | 注意、可動部品 | | 本製品は、お子様向けのものではありません。(シュレッターで遊ばないこと)。 | | フロッピーディスクは本機で裁断できません。 |
| | 注意、鋭いエッジ | | 用紙投入口に手を触れないでください。 | | CD/DVDを廃棄する際は、必ず保護メガネを着用すること! |
| | 本製品を錆びつく恐れのある物質の近くで使用しないでください。 | | | | メンテナンスを行う前に、必ず電源プラグを抜いてください。 |

- | | | | | | |
|--|-------------------------------|---|--|--|--|
|  | 技術仕様 - 内容は予告なく変更される場合があります |  | セキュリティ レベル - O
CD、DVDの破壊 |  | 作動中 |
|  | 空回り時の騒音レベル |  | セキュリティ レベル - T
カード破壊 |  | オートオフ |
|  | 細断速度 |  | セキュリティレベル - E
チップカードの破壊 |  | 長時間作動したり過負荷の状態になると、自動的にオフになって本体を冷まします。 |
|  | 用紙 - ストレートカット |  | 用紙 - クロスカット |  | メンテナンスについて /
トラブルの解消 |
|  | 用紙 - クロスカット |  | CD/DVD - クロスカット |  | ダストボックスが満杯です |
|  | CD/DVD - ストレートカット |  | カード - クロスカット |  | 故障かなと思ったら |
|  | CD/DVD - クロスカット |  | 質量 |  | 本機が開いたままになった場合のオートオフ機能 |
|  | カード - ストレートカット |  | プラグで電源の入/切を行います |  | 装置の過熱 |
|  | カード - クロスカット |  | 保護接地されたメインソケットは、いつでも簡単にアクセスできる必要があります。 |  | モーターがブロックされた |
|  | セキュリティ レベル - P
紙のシュレッダー |  | 操作 | | |
|  | セキュリティ レベル - F
マイクロフィルムの破壊 |  | スタンバイ中 | | |

CN 使用说明

1.1 预定用途，保修



注意!

使用碎纸机之前，请仔细阅读本操作说明书和安全指南。

必须遵守本指南的内容!

妥善保管本操作说明书，以备将来使用。



目录

1	重要信息.....	85
1.1	常规使用，保修.....	85
1.2	安全指南.....	85
1.3	图形符号图例.....	86
1.4	供货范围.....	88
1.5	技术数据.....	88
2	操作.....	89
2.1	拆除运输锁.....	89
2.2	将设备与电源相连.....	90
2.4	接通设备.....	90
2.5	纸张粉碎.....	91
2.8	持续进纸.....	92
2.9	CD/DVD、卡片粉碎.....	93
3	保养/故障排除.....	95
3.1	清空粉碎物.....	95
3.3	容器/盖板呈打开状态.....	95
3.4	加热.....	96
3.6	手动送纸塞纸.....	96
3.7	清洁设备.....	97
3.9	给滚刀组上油.....	98

本碎纸机用于粉碎纸张。

根据机器型号的不同可以粉碎少量以下物品：

- CD/DVD、支票和信用卡（详见技术数据）。
- 在纸质文档中以及通常使用的订书钉及回形针（例外情况：P6 和 P7 安全等级设备）。

由于不恰当使用或从第三方购买造成的磨损及损坏不属于保修或保证范围。

碎纸机设计用于在私人场所和正常办公环境下运行。

根据技术数据页数容量的规定，适用下列条件：

在下列条件下单次切碎的最大纸张数量：加油润滑过的新碎纸辊（若有必要）、冷电动机、具有额定电压和频率（230 伏特/50 赫兹；120 伏特/60 赫兹）。偏差可能导致较低的纸张容量，并在操作期间增加噪音。纸张应在 90°C 下纵向置中插入。纸张容量可能因为纸张特性与入口不同而变化。

1.2 安全指南

- 请保证电源x的电压和频率与铭牌上的指示相符。
- 不要将本设备置于热源附近!
- 本设备只能以直立状态放置、运输及运行!
- 本设备上只能使用符合 DAHLE 规定的液体或气体!
- 不要打开本设备!

- 本设备只能在温度为 10° C 至 25° C (华氏 50° F 到 77° F) 且非凝湿度为 15% 至 95% 的室内使用!
- 确保房屋安装的短路保险丝工作正常: 最大电流 16 安 (美国最大电流 20 安)。
- 不要让设备空转!
- 身体、知觉或精神有障碍以及缺乏设备操作经验知识的人士 (包括孩子) 不得操作该设备。正常人只有在安全人员监督下, 或得到全面设备使用指导的情况下才可使用设备。



以专业环保方式报废碎纸机, 将垃圾送到认可的回收站处置。请不要将碎纸机的部件或包装与生活垃圾一同处置。

1.3 图形符号

 重要信息	 使用时请远离易燃易爆液体及气体。	 请在销毁文件前去掉回形针和钉书针!
 阅读使用者信息/安全指南	 自动开机	 未插入软盘!
 注意	 不要暴露在潮湿的环境中	 销毁 CD / DVD 时, 必须佩戴护目镜!
 注意! 有电击危险。	 不要让儿童使用本碎纸机 (本产品不是玩具)。	 维修碎纸机前要断电!
 注意, 活动部件	 请不要用手接触进纸入口。	 技术数据 — 保留技术变更的权利!
 注意, 锐利的边缘	 请不要让衣服接触进纸入口!	 空转时的机器噪音
 使用时请远离腐蚀性物品。	 请不要让毛发接触进纸入口!	 卷入速度
 将本设备平稳地直立在地面上, 离墙 100 毫米, 避免操作紧急制动时, 热量积聚 (取决于型号)	 远离喷雾罐!	 纸张碎片

- | | | | | | |
|--|-----------------------------|--|--------------------------|--|-------------------------------------|
| | 纸张碎粒 | | セキュリティ レベル-T
カード破壊 | | 自动关机! |
| | CD/DVD 碎片 | | セキュリティレベル-E
チップカードの破壊 | | 在延长操作时间和/
或过载时, 碎纸机会
自动关机以降温。 |
| | CD/DVD 碎粒 | | 重量 | | 维护指南 / 故障排除 |
| | 卡片碎片 | | 电源插头用作断电装置! | | 容器已满 |
| | 卡片碎粒 | | 电源插座必须接地,
并且随时都可轻松访问! | | 可能的故障 |
| | セキュリティ レベル-P
紙のシュレッダー | | 操作 | | 打开机壳时会自动
关机 |
| | セキュリティ レベル-F
マイクロフィルムの破壊 | | 准备状态下的碎纸机 | | 过热 |
| | セキュリティ レベル-O
CD、DVDの破壊 | | 使用状态下的碎纸机 | | 电机堵转 |

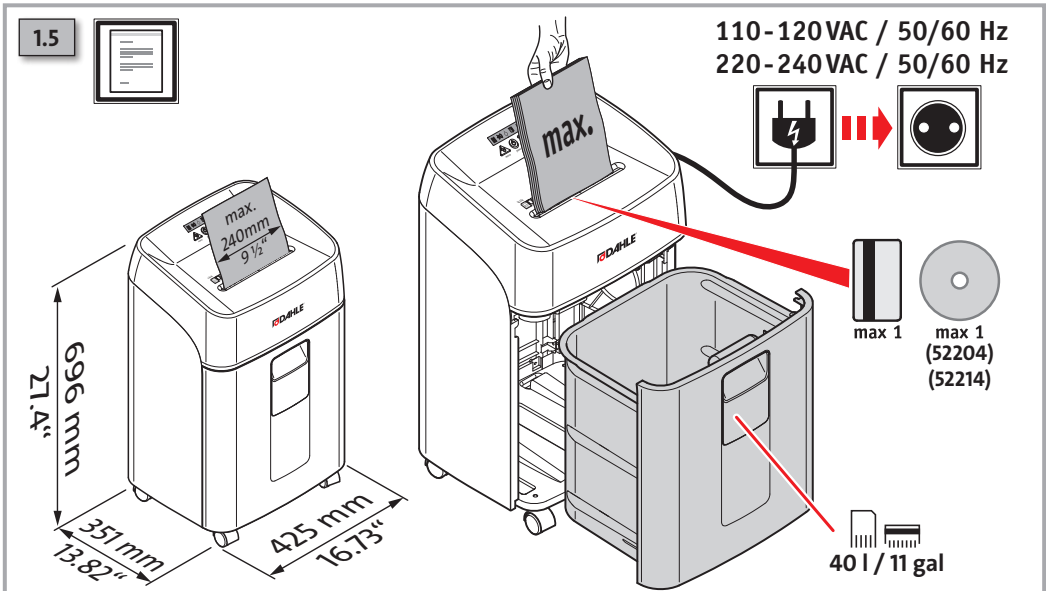
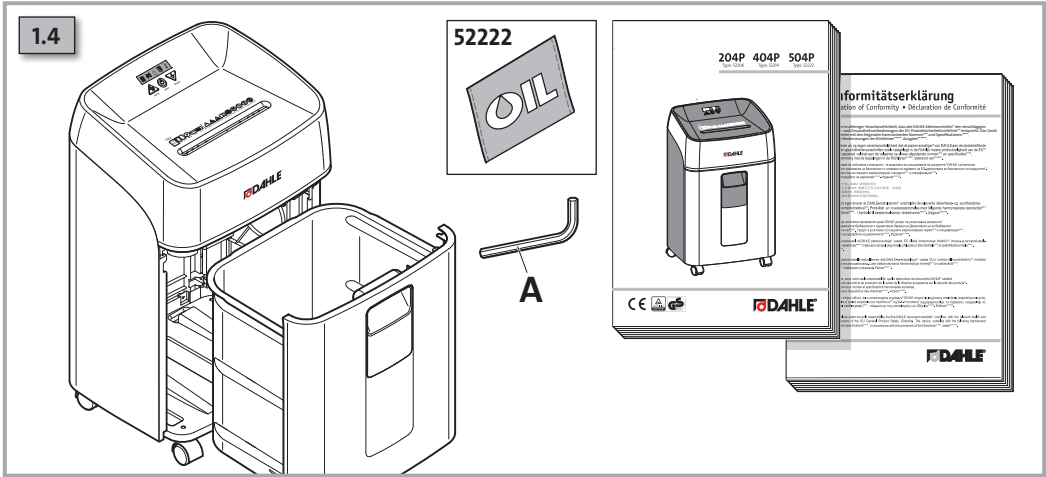

Type											
	mm / in	mm / in									
	DIN 66399										
52204	4 / 1/8		P-2		O-2	T-2	E-2	70/80 g 16/20 lb	kg / lbs 20,1 / 44,3	m/min f/min 2,0 / 6,6	(dB(A)) <60
52214	4x35 / 1/16 x 1 3/8		P-4	F-1	O-3	T-4	E-3	19-21	23,9 / 52,7	2,1 / 6,9	<60
52222	2x15 / 1/16 x 9/16		P-5	F-2		T-5	E-4	13-15	23,1 / 50,9	2,1 / 6,9	<60



2.1

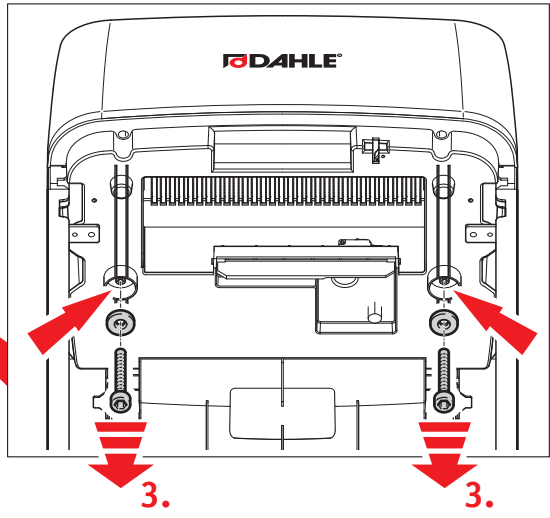
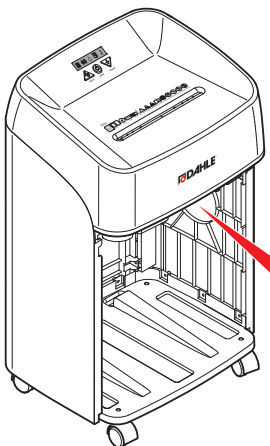
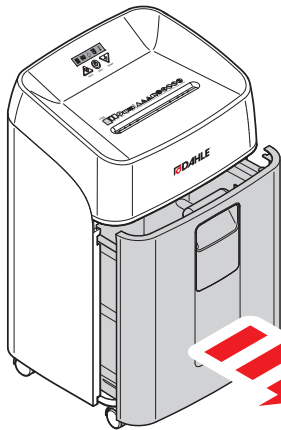

2



2.2



2.3

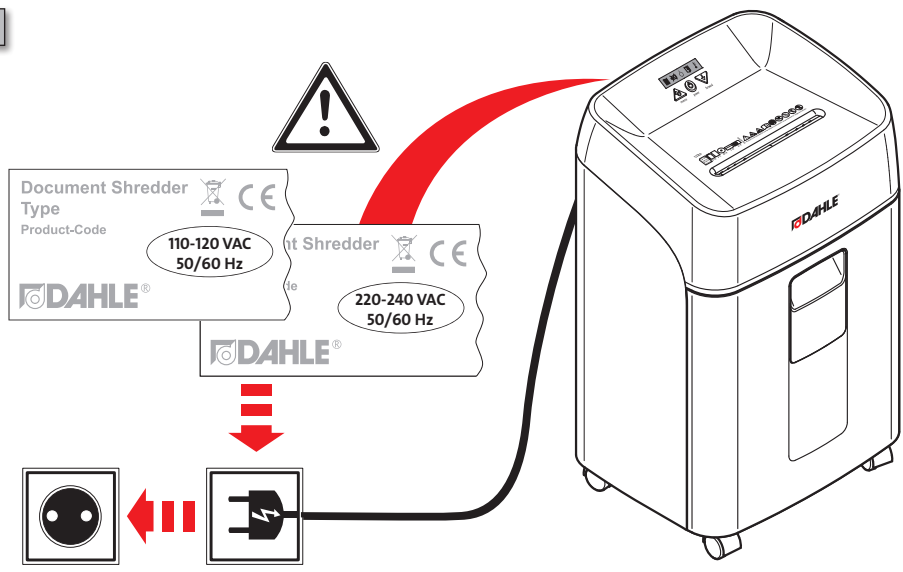

2.4



2



2.5



2.6

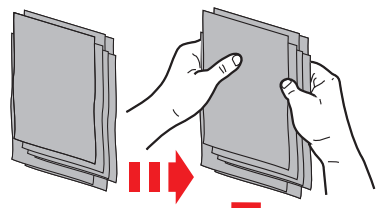

O.K.

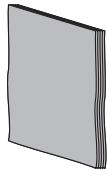

O.K.



2.7

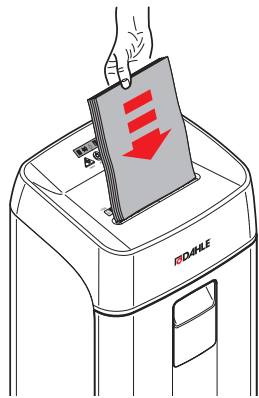



2.8

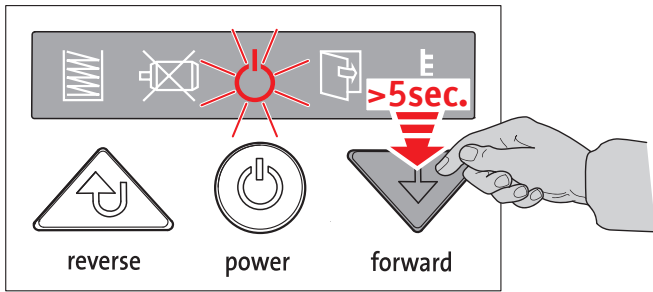

5min

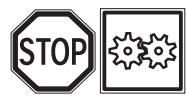
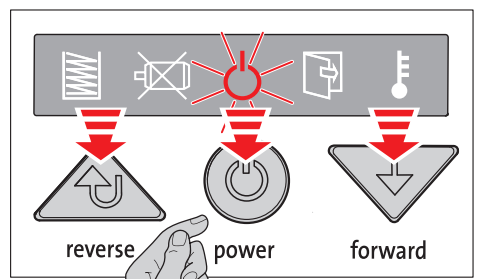



2.9



2.10

O.K.



CD/DVD

Type	
52204	✓
52214	✓
52222	✗

O.K.

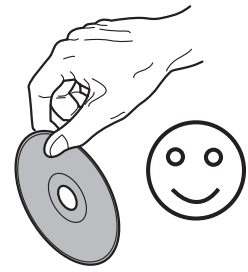

~~O.K.~~

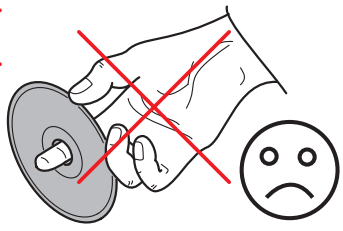

2.11

max. 1

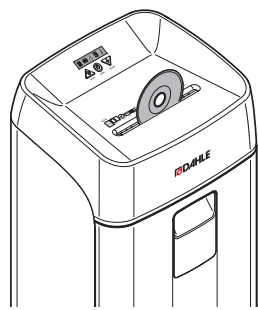
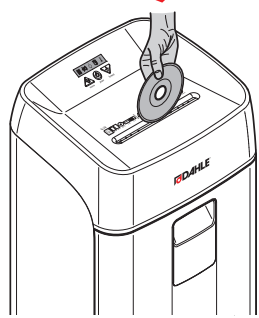



2.12

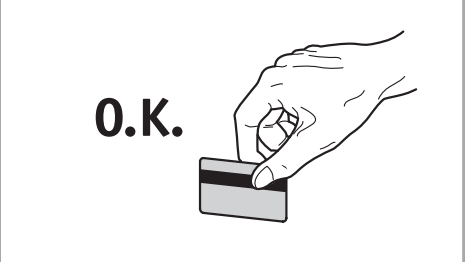
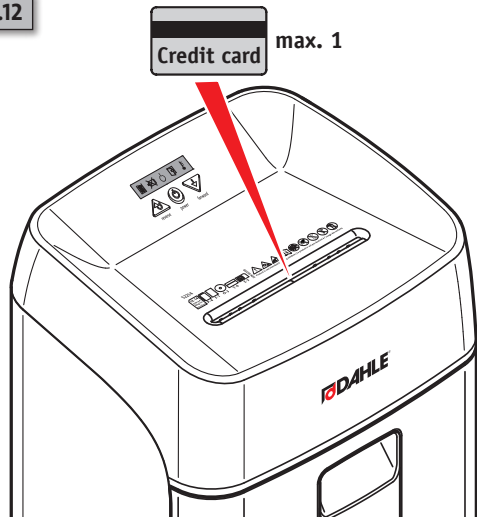

2.13

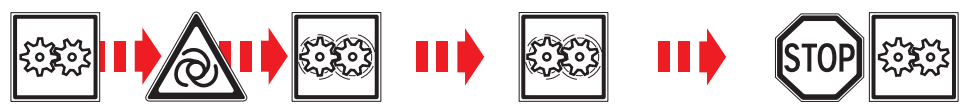



3.1



~~O.K.~~

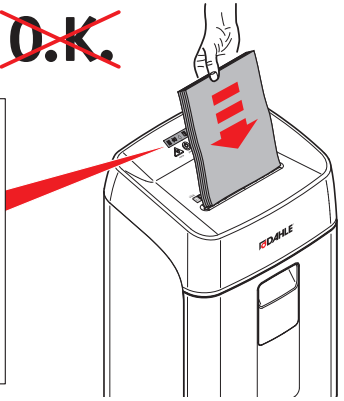
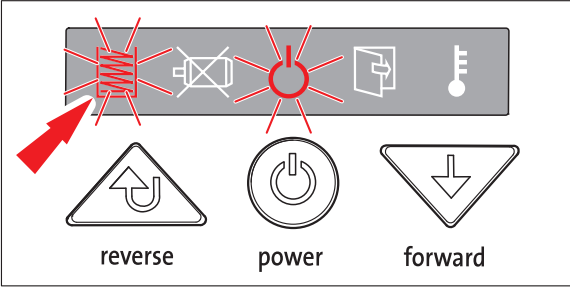

3.2



1.

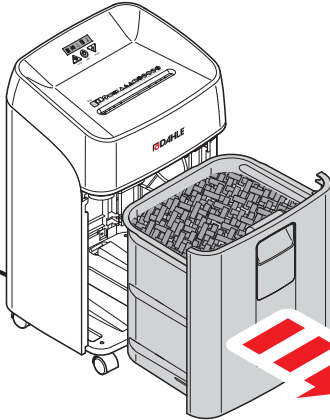

3.



2.

2.4

3.3

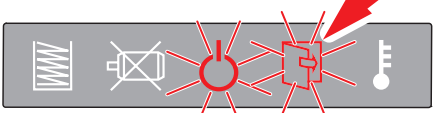

reverse



power

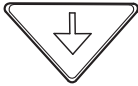

forward

1.



2.



3.4

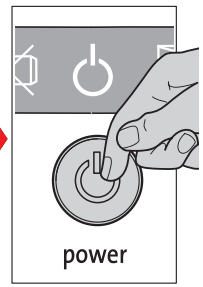
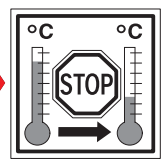
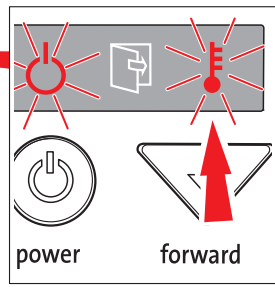

3.5

Type	ON	OFF
52204 / 204P	>40 min*	45 min*
52214 / 404P	>65 min*	45 min*
52222 / 504P	>40 min*	45 min*

* → www.novus-dahle.com

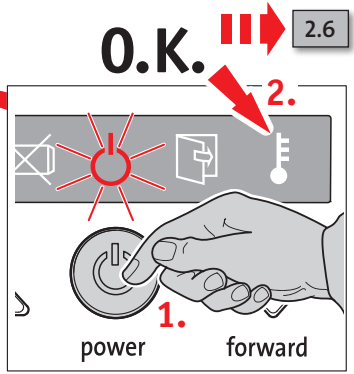

2.6

3.6

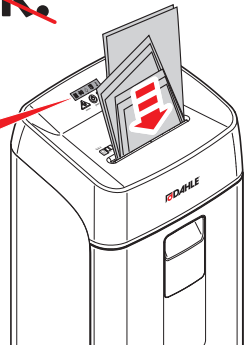
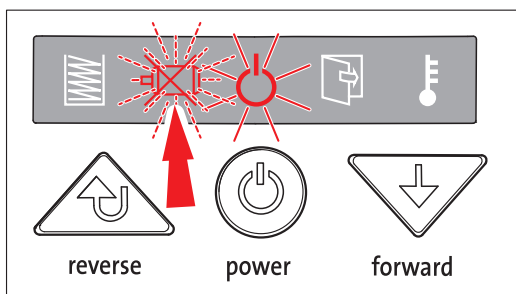



3.7

2.

reverse power

1. 3 Sek.

3.

2.6

3.8



1.

2.



3.9



1.

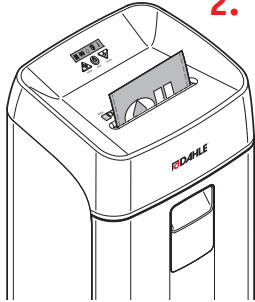

2.

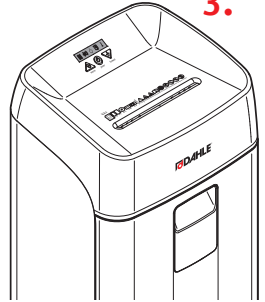

3.

Type	
52204	X
52214	X
52222	✓



10 Sek.

4. reverse



power

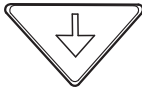

forward



5.



10 Sek.

Headquarters:

Novus Dahle GmbH
Breslauer Straße 34 - 38
DE-49808 Lingen (Ems)

Service contact:

Novus Dahle GmbH
Nikolaus-A.-Otto-Straße 11
96472 Rödental · Germany
Tel. +49 (0) 9563 75299-0
Fax +49 (0) 9563 75299-333
info@novus-dahle.com
www.novus-dahle.com