

CANNONBALL

cluster 3 | user guide



UMAGE



WITH LOVE FROM COPENHAGEN

At UIMAGE, our designers take inspiration from the distinct nature of the Nordic landscape to create unique designs related to the way we live in an urban setting. Influenced by the design language, colours and materials found around us in Scandinavia, we create a collection that is rooted in our home but designed for everyone.

Versatile, flexible and multifunctional, our furniture and accessory collection is designed for packing the most into life in smaller spaces!



ENGLISH

IMPORTANT! Always shut off power to the circuit before starting installation work. In some countries electrical installation work may only be carried out by a authorised electrical contractor. Contact your local electricity authority for advice.

As wall materials vary, screws for fixing to wall are not included. For advice on suitable screw systems, contact your local specialised dealer.

DEUTSCH

WICHTIG! Vor der Installation den Strom abschalten. In einigen Ländern dürfen Elektroinstallationen nur von autorisierten Elektrofachleuten ausgeführt werden. Im Zweifelsfall die örtlichen Behörden ansprechen.

Da es viele verschiedene Wandmaterialien gibt, sind Schrauben für die Wandbefestigung nicht

beigepackt. Ggf. sollte man sich beim Eisenwarenfachhandel nach geeignetem Befestigungsmaterial erkundigen.

FRANÇAIS

ATTENTION! Toujours couper l'alimentation au panneau principal avant de procéder à l'installation. Dans certains pays, l'installation doit être effectuée par un électricien qualifié. Pour en savoir plus, contacter les autorités locales compétentes en la matière.

Les vis et ferrures pour fixer le meuble/l'objet au mur ou au plafond ne sont pas incluses. Choisissez des vis et ferrures adaptées au matériau de votre mur. En cas de doute, demandez conseil à un vendeur spécialisé.

NEDERLANDS

BELANGRIJK! Schakel de stroom altijd uit voordat met de installatie wordt begonnen. In sommige landen mogen elektrische installaties alleen worden uitgevoerd door een bevoegd elektricien. Neem daarom contact op met de plaatselijke overheid voor advies.

Omdat er zoveel verschillende soorten wandmaterialen zijn, zitten er geen schroeven voor de wandbevestiging in de verpakking. Voor advies over geschikte schroeven, neem contact op met de plaatselijke vakhandel.

DANSK

VIGTIGT! Sluk altid før strømmen, før installationen påbegyndes. I nogle lande må elektriske installationer kun udføres af en uddannet elektriker. Få oplysninger hos de relevante myndigheder.

Der findes mange forskellige vægmaterialer, og derfor medfølger der ikke skruer til vægmontering. Hvis du har brug for råd om forskellige skruer og rawlplugs, skal du kontakte en uddannet forhandler.

ÍSLENSKA

MIKILVÆGT! Sláíð rafmagnið úr áður en uppsetning hefst. Í sumum löndum þarf uppsetning að vera framkvæmd af löggiltum rafvirkja. Leitið ráða hjá rafvirkja varðandi uppsetninguna.

Veggir húsa eru mismunandi og því fylgja ekki skrúfur til að festa húsgagnið við vegg. Fáíð ráð í byggingavöruverslun varðandi hentugar skrúfur.

ČESKY

DŮLEŽITÉ! Před instalací vždy odpojte ze sítě. V některých zemích může instalaci provést pouze kvalifikovaný elektrikář. Kontaktujte o radu nejbližšího elektrikáře.

Stěny bývají z různých materiálů, a proto šrouby nejsou součástí balení výrobku. Vhodný typ šroubů vám doporučí ve specializované prodejně.

ESPAÑOL

IMPORTANTE! Desconecta siempre el interruptor general de la electricidad antes de iniciar cualquier trabajo de instalación. En algunos países, la instalación eléctrica sólo puede realizarla un electricista profesional. Ponte en contacto con las autoridades locales para saber cuál es tu caso.

Como hay tantos tipos de paredes, no se incluyen los tornillos para el montaje en la pared. Para recomendaciones sobre sistemas adecuados, ponte en contacto con un especialista.

ITALIANO

Togli sempre tensione al circuito prima di iniziare l'installazione. In alcune nazioni l'installazione

elettrica può essere effettuata solo da un elettricista autorizzato. Per maggiori informazioni, contatta l'autorità locale per l'energia elettrica.

Poiché le pareti sono di materiali diversi, le viti per il fissaggio non sono incluse. Per scegliere le viti adatte, rivolgiti a un rivenditore locale.

MAGYAR

FONTOS! Minden esetben kapcsolj le az áramot mielőtt elkezded a munkát. Néhány országban elektromos installációt kizárólag szakember végezhet. Ezzel kapcsolatban érdeklődj elektromos szolgáltatódnál.

Mivel a fal anyaga lakásonként / otthononként változó lehet, a rögzítéshez szükséges csavarokat, tipliket a csomag nem tartalmazza. A megfelelő csavarok kiválasztásáért kérj tanácsot az áruházban a szakképzett személyzettől.

POLSKI

WAŻNE! Przed rozpoczęciem instalacji odłącz zasilanie. W niektórych państwach instalacje elektryczne mogą być wykonywane wyłącznie przez wykwalifikowanych elektryków. Skontaktuj się z odpowiednimi instytucjami, aby uzyskać poradę.

Ponieważ materiał, z którego wykonano ścianę może być inny w każdym mieszkaniu, w komplecie nie znalazły się żadne umocowania ani wkręty. Aby uzyskać poradę w kwestii doboru odpowiednich wkrętów skontaktuj się z lokalnym sklepem specjalistycznym.

EESTI

OLULINE! Lülitage alati enne paigaldustööde alustamist elekter välja. Mõnes riigis võib elektritööd teostada ainult litsentseeritud elektrik. Võtke ühendust kohaliku elektriteenust pakkuva asutusega. Seinamaterjalide erinevuse tõttu

pole lisatud kruvisid. Sobivate kin-nitusvahendite leidmiseks pöörduge lähimasse tööriistapoodi.

LATVIEŠU

SVARĪGI! Pirms montāžas darbu uzsākšanas vienmēr atvienojiet galveno strāvas padevi. Dažās valstīs elektroinstalācijas darbus drīkst veikt tikai sertificēts elektriķis. Neskaidrību gadījumā sazinieties ar savu vietējo energoapgādes uzņēmumu.

Skrūves piestiprināšanai pie sienas nav iekļautas komplektā, jo tās jāizvēlas atkarībā no sienu materiāla. Lai izvēlētos piemērotāko skrūvju sistēmu, sazinieties ar būvniecības speciālistu.

LIETUVIŲ

SVARBU! Prieš pradėdami elektros instaliacijos darbus, visada išjunkite elektros energiją. Kai kuriose šalyse elektros instaliacijos darbus gali atlikti tik leidimą tam turintis elektrikas.

Kreipkitės į atitinkamas institucijas ir pasitikslinkite.

Kadangi sienų apdailos medžiagos skiriasi, tvirtinimo elementai nepridedami. Reikalingus varžtus ir tvirtinimo elementus padės pasirinkti vietos specializuotas pardavėjas.

PORTUGUÊS

IMPORTANTE! Desligue sempre a corrente eléctrica antes de começar um trabalho de instalação. Em alguns países os trabalhos de instalação eléctrica só podem ser realizados por um electricista autorizado. Contacte a sua autoridade local de electricidade para aconselhamento.

Como os materiais de parede variam, os parafusos para fixar à parede não estão incluídos. Para obter conselho sobre o sistema de parafusos adequado, consulte o seu retalhista local especializado.

ROMÂNĂ

ATENȚIE! Opriți întotdeauna alimentarea cu curent electric înainte de a începe lucrările de instalare. În unele țări, operațiunile de instalare pot fi efectuate numai de către un instalator autorizat. Pentru mai multe informații, contactați autoritatea locală care gestionează energia electrică.

Întrucât materialele din care sunt construiți pereții variază, șuruburile pentru fixarea pe perete nu sunt incluse. Contactează dealer-ul tău local pentru consiliere.

SLOVENSKY

DÔLEŽITÉ! Pred inštaláciou vždy odpojte zo siete. Zistite si, či nepatríte medzi tie krajiny, kde inštaláciu môžte uskutočniť výlučne elektrikár. O radu požiadajte vašu lokálnu autoritu.

Na rôznych typoch stien použite vhodné skrutky. Ak si neviete dať rady, poraďte sa s miestnym predajcom.

HRVATSKI

VAŽNO! Uvijek isključite struju prije instalacije. U nekim zemljama postavljanje električnih instalacija može obavljati samo ovlašteni električar. Za savjet kontaktirajte svog lokalnog ovlaštenog električara.

S obzirom na različite vrste zidova, vijci za pričvršćivanje na zid nisu priloženi. Za savjet o odgovarajućim vijcima kontaktirajte svoju lokalnu specijaliziranu prodavaonicu.

ΕΛΛΗΝΙΚΑ

ΣΗΜΑΝΤΙΚΟ! Πριν από την έναρξη της εργασίας εγκατάστασης, να διακόπτετε πάντα την παροχή ρεύματος από τον γενικό διακόπτη. Σε μερικές χώρες, οι ηλεκτρολογικές εργασίες θα πρέπει να πραγματοποιούνται μόνο από ένα εξουσιοδοτημένο ηλεκτρολόγο. Για πληροφορίες, επικοινωνήστε με την εταιρία ηλεκτρισμού της περιοχής σας.

Επειδή τα υλικά των τοίχων διαφέρουν, οι βίδες στερέωσης δεν περιλαμβάνονται. Για πληροφορίες, σχετικά με το ενδεδειγμένο κατά περίπτωση σύστημα στερέωσης, παρακαλούμε ελάτε σε επαφή με το ειδικευμένο κατάστημα της περιοχής σας.

SRPSKI

BITNO! Uvek isključite struju pre nego što počnete s intaliranjem. U pojedinim državama elektro-instalacije mogu da postave samo osobe s ovlašćenjem. Obratite se lokalnoj elektro-distribuciji za savet.

Kako se vrste zidova razlikuju, tiplovi nisu uključeni. Obratite se specijalizovanim radnjama radi uputstva o odgovarajućim tiplovima.

РУССКИЙ

ВНИМАНИЕ! Перед установкой всегда отключайте электропитание. В некоторых странах электроустановка

должна производиться только квалифицированным электриком. Обратитесь за консультацией в соответствующие местные инстанции.

Так как материалы стен различаются, шурупы для фиксации на стене не прилагаются. Для выбора подходящих крепежных средств обратитесь в местный специализированный магазин.

SLOVENŠČINA

POMEMBNO! Pred začetkom dela vedno izklopite električno napajanje. V nekaterih državah sme električno napeljavo napeljevati le pooblaščen električar. Za nasvet se obrnite na najbližji pooblaščen servis.

Ker se stenski materiali razlikujejo, vijaki niso priloženi. Za nasvet glede primerne vrste vijakov se obrnite na najbližjo specializirano trgovino.

БЪЛГАРСКИ

ВАЖНО! Винаги изключвайте електрозахранването във веригата, преди да извършвате работа по инсталацията. В някои страни работа по електрическите инсталации може да се извършва единствено от оторизиран електротехник. За препоръка се обърнете към местната електрическа компания.

Поради разнообразието от стенни материали, винтове за прикрепяне към стената не са осигурени. За съвет относно подходящи прикрепващи механизми можете да се свържете със специализиран доставчик.

TÜRKÇE

ÖNEMLİ! Kurulumu başlamadan önce her zaman elektrik devresini kapatınız. Bazı ülkelerde elektrik kurulum işlemi sadece yetkili elektrik teknikerleri tarafından yapılmaktadır. Size en yakın yerel elektrik idaresi ile temas kurarak bu konuda bilgi alabilirsiniz.

Duvar yapı malzemeleri farklılık gösterebileceğinden duvar montajı vidaları dahil değildir. Uygun vida sistemi için, ilgili araç-gereçlerin satıldığı dükkanlara başvurunuz.

BAHASA INDONESIA

PENTING! Selalu matikan listrik ke sirkuit sebelum memulai pekerjaan pemasangan. Di beberapa negara pekerjaan pemasangan listrik hanya boleh dilakukan oleh tukang listrik tersertifikasi. Hubungi tukang listrik berwenang di tempat anda untuk saran.

BAHASA MALAYSIA

PENTING! Sentiasa padamkan bekalan kuasa ke litar sebelum memulakan kerja-kerja pemasangan. Di beberapa negara kerja-kerja pemasangan elektrik hanya boleh dilakukan oleh kontraktor elektrik yang bertauliah. Hubungi pihak berkuasa tempatan untuk mendapatkan nasihat tentang bekalan elektrik.

中文 - 重要事项

安装工作开始前，请务必切断电路电源。在一些国家，电气安装必须由有资质的电力承包商完成。请联系您当地的电力部门，征询建议。

本产品不附带安装螺钉。墙体材料不同，墙面安装使用螺钉须根据具体墙体材料进行适宜选择。必要时，应向专业五金店咨询。

繁中 - 重要訊息

安裝前請務必關掉電源。有些國家的電力安裝工作需由有執照的專業電工執行，如有任何疑問，請聯絡專業人員。

由於牆壁的材質每戶不同，故所需的螺絲或配件需另購買。若不知使用何種螺絲配件，請向當地的五金行詢問。

한국어 - 중요!

설치작업을 시작하기 전 반드시 회로의 전원을 차단하세요. 일부 국가에 서는 공인전기시공업체만 전기 공사를 진행할 수 있습니다. 관련 정보는 지역 전력 관할 기관에 문의하세요.

벽마다 소재가 다르기 때문에 벽고정용 나사는 포 포함되어 있지 않습니다. 적합한 나사 선택에 관해서 는 전문가에게 문의하세요.

日本語 - 重要

設置作業を開始する前に必ずブレーカーを切ってください。電気工事の作業を行うには、資格を必要とする国もあります。お近くの電気工事店にご相談ください。



DESIGNED BY
SØREN RAVN CHRISTENSEN

“ Inspired by a sphere,
the Cannonball is a
contemporary canopy
for your pendant. ”

ASSEMBLY GUIDE

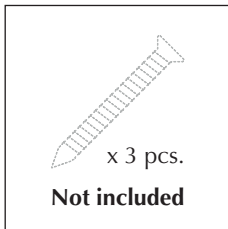

(A) x 1 pc.



(B) x 1 pc.

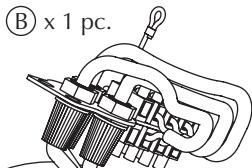

(C) x 3 pcs.

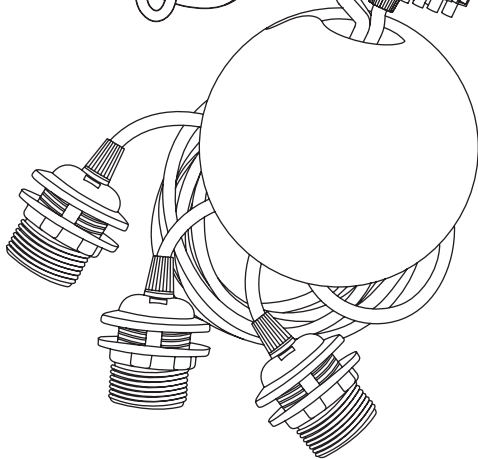

Find assembly videos by using the QR code or by going online at our website
umage.com/instructions

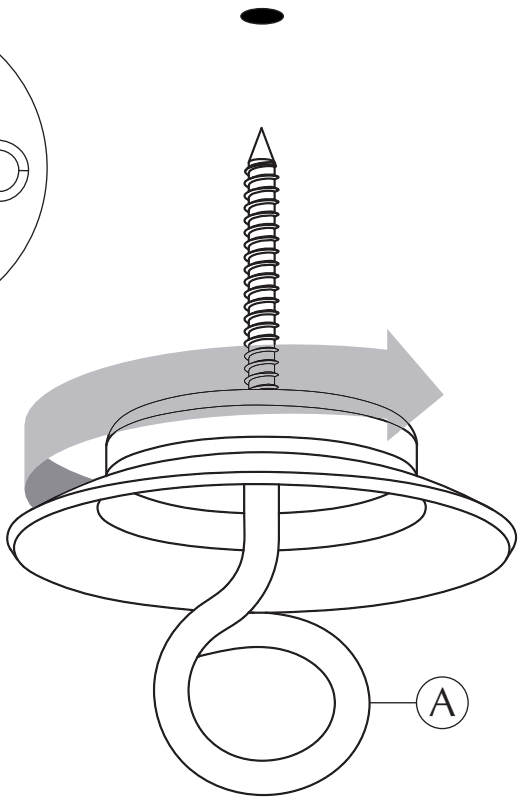
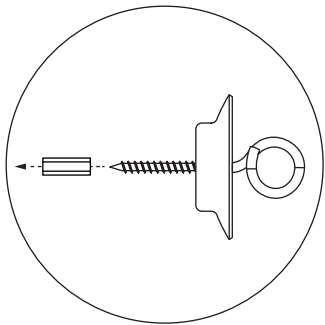

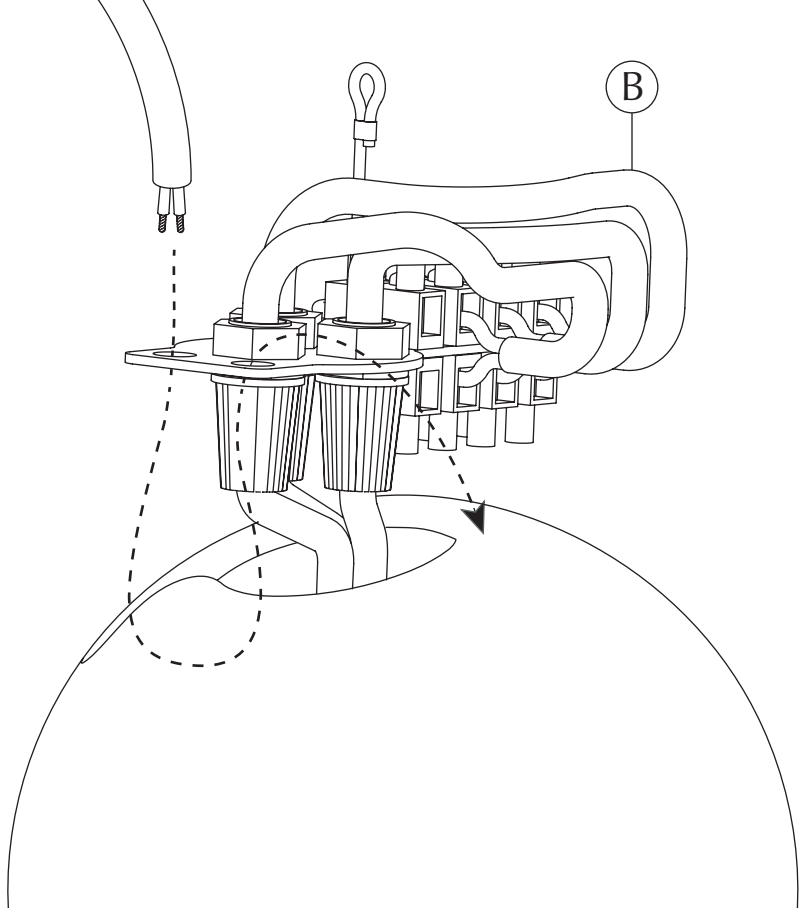

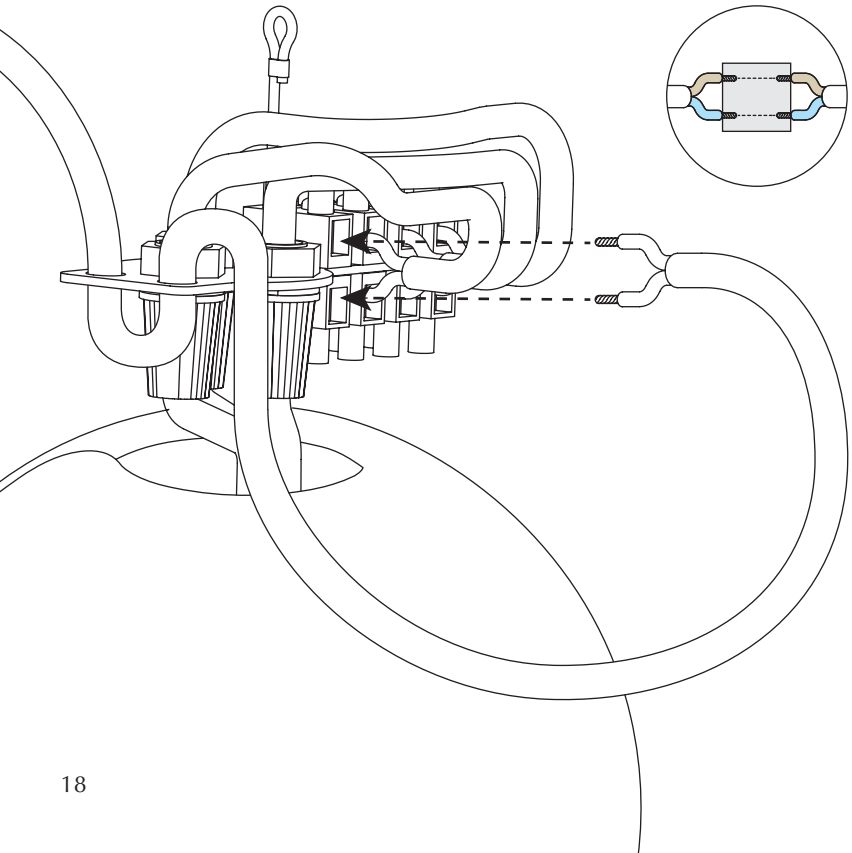

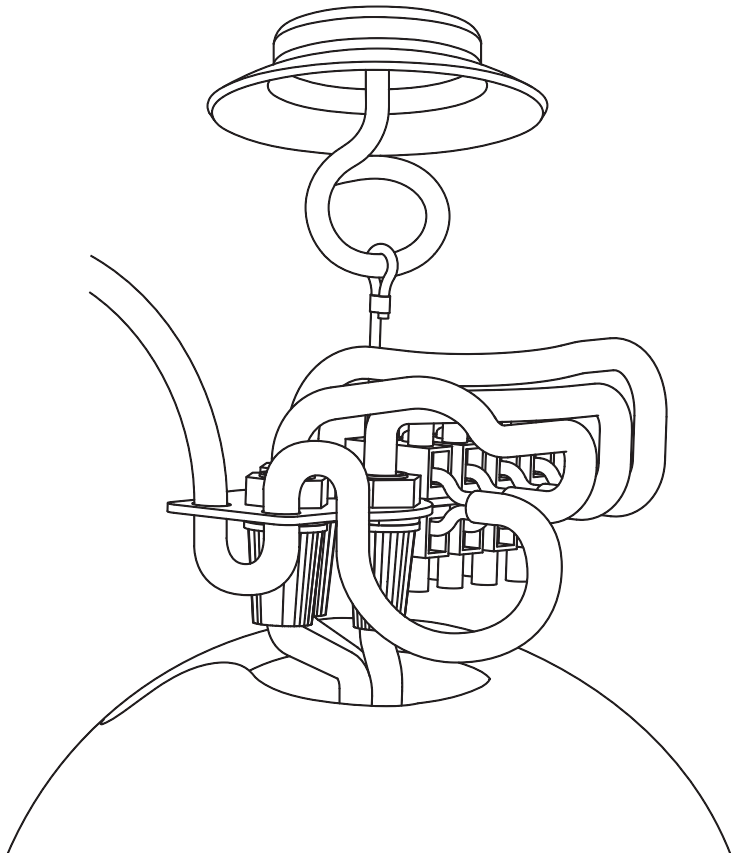

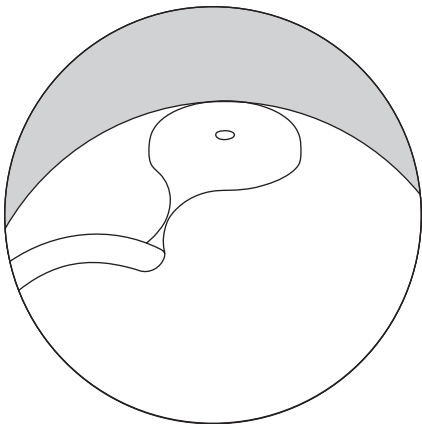
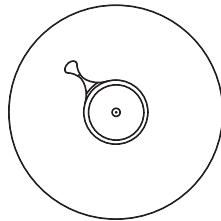
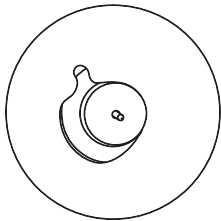
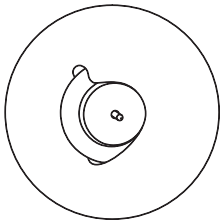

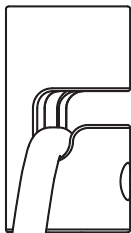
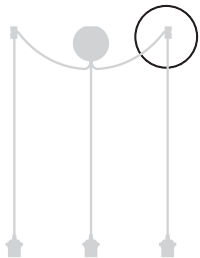

C

CLAVA DINE
lampshade | black



HANG IN THERE
wall hanger | black



SUSTAINABLE SUSTAINABILITY EFFORTS

We are dedicated being sensible frontrunners on the environmental responsibility. If we provide timeless and functional quality designs that last, we know nature will prevail, as will UIMAGE.

*"SAVING THE SCENT OF THE FOREST
AFTER AN EARLY MORNING RAIN"*

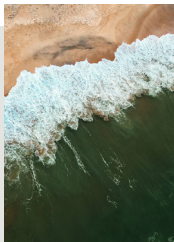

GIVING BACK TO NATURE

In collaboration with the NGO One Tree Planted, we are planting a tree every time one of our designs made from wood are being sold.

MULTIFUNCTION AND FLEXIBILITY

One of the key aspects of the designs at UIMAGE is multiple functions and flexibility. Designing with more than one function in mind is a sustainable mindset as it reduces the number of products you need to buy to get a complete setting for your space.

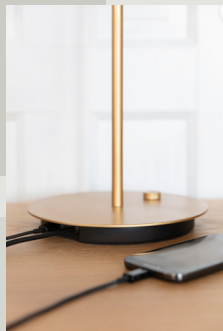

REUSABLE PACKAGING

To minimize packaging waste, most of the packaging from our lighting collection is repurposed to be used as beautiful storage boxes afterwards. Learn more on the next page...



REUSABLE PACKAGING

With your new lamp, you have also received a free decorative storage box for the shelf.

THIS IS HOW IT WORKS

When your new lamp is out of the box you can keep the box and reuse it as a storage box for your small bits and bobs and place it on the shelf or on the top of your closet - repurposing the packaging for you and the environment.

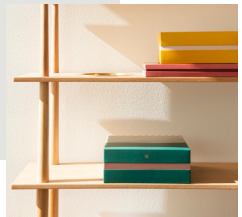

So not only are UIMAGE's designs flat-packed to optimize the global logistics and the environmental footprint, but it ensures that you don't need to throw away tons of packaging material, that can just as well be reused for something new.

Read more about our many sustainability efforts:
umage.com/sustainability



Please follow the marked icons on the packaging materials for correct disposal of the remaining packaging materials:



CARDBOARD



PAPER



Recycle your waste correctly
by searching for these icons on
the packaging

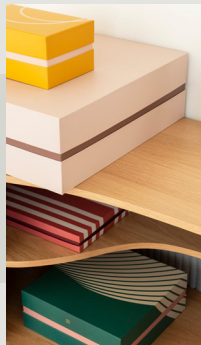

FOLLOW US ON SOCIAL MEDIA



@umagedesign | #umagedesign | umage.com



UMAGE



220523