

# TOBIA

HP145 1F EXT  
HP145 2P EXT  
HP145 3R EXT

AC145 5A INT  
AC145 4A INT

220-240V  
17,2W LED, 1550 lumen - 3000K, dimmable

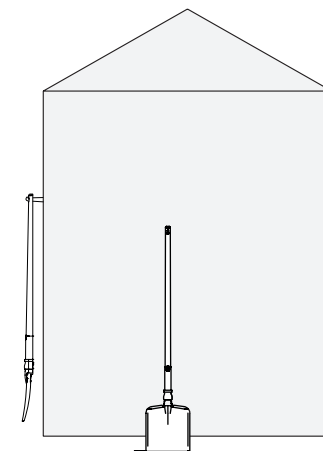
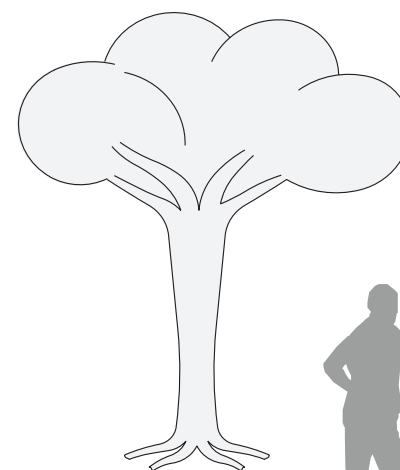

IP65   

Karman srl

Via A. Grandi, San Martino del piano, 61034 Fossombrone (PU), Italy - p.iva 02175640412 tel +39 0721 71 5042 r.a fax +39 0721 716640 - [www.karmanitalia.it](http://www.karmanitalia.it)

Il cavo flessibile esterno di quest'apparecchio viene gamineggiato, deve essere sostituito dal costruttore o dal servizio di assistenza o da personale qualificato equivalente al fine di evitare pericoli.  
-Togliere tensione prima dell'installazione o di qualsiasi manutenzione.  
-Il prodotto deve essere montato da personale qualificato, rispettando le norme impianti in vigore.

 <p>0-14</p>	Attenzione! Apparecchio artistico, tenere lontano dalla portata dei bambini.		Attenzione! Rischio scossa elettrica. Togliere la tensione elettrica in assenza di lampadina.
--	--	---	---

EN If the flexy cord on the outside of this appliance becomes damaged, it must be replaced by the manufacturer or by its assistance service or a qualified service engineer, in order to avoid all hazard risks.  
-Disconnect from the mains power before installing or carrying out any maintenance.  
-This item must be fitted by a qualified person, compliant with current installation regulations.

 <p>0-14</p>	Warning! Artistic appliance. Keep out of the reach of children.		Warning! Electric shock risk. Disconnect from the mains power if no light bulb is fitted.
--	---	---	---

FR Si le câble souple externe de cet appareil est endommagé, il doit être remplacé par le fabricant, par son service d'assistance ou par une personne qualifiée afin d'éviter tout danger.  
-Couper l'alimentation avant l'installation ou toute opération d'entretien.  
-Le produit doit être installé par un personnel qualifié, en respectant les règles d'installation en vigueur.

 <p>0-14</p>	Attention! Cet appareil n'est pas un jeu, tenir hors de la portée des enfants.		Attention! Risque de choc électrique. Couper l'alimentation électrique en l'absence d'ampoule.
--	--	---	--

DE Wenn das äußere Kabel dieses Gerätes beschädigt wird, muss es durch den Hersteller, den Kundendienst oder ähnlich qualifizierte Personen ersetzt werden, um Gefahren zu vermeiden.  
-Unterbrechen Sie die Stromversorgung vor der Installation oder Wartung.  
-Das Produkt darf nur von qualifizierten Personen und unter Beachtung der geltenden Anlagenvorschriften installiert werden.

 <p>0-14</p>	Achtung! Kein Spielzeug! Bitte von Kindern fernhalten.		Achtung! Stromschlaggefahr. Unterbrechen Sie die Stromversorgung, falls keine Glühbirne eingeschraubt ist.
--	--	---	--

ES Si el cable flexible externo de este aparato se daña debe ser sustituido por el fabricante o el servicio de asistencia o personal cualificado equivalente para evitar peligros.  
-Quitar tensión antes de proceder con la instalación o cualquier trabajo de mantenimiento.  
-El producto debe ser montado por personal cualificado de conformidad con las normas vigentes para instalaciones.

 <p>0-14</p>	¡Atención! Aparato artístico, mantener alejado del alcance de los niños.		¡Atención! Riesgo de choque eléctrico. Desconectar la tensión eléctrica en ausencia de bombilla.
--	--	---	--

PT Se o cabo flexível externo deste aparelho for danificado, deve ser substituído pelo fabricante ou pelo serviço de assistência ou por pessoal qualificado equivalente, para evitar perigos.  
-Desligue a tensão antes da instalação ou qualquer operação de manutenção.  
-O produto deve ser montado por pessoal qualificado, respeitando as normas dos sistemas em vigor.

 <p>0-14</p>	Atenção! Aparelho artístico, manter longe do alcance das crianças.		Atenção! Risco de choque elétrico. Desligar a tensão elétrica na ausência de lâmpada.
--	--	---	---

NL Om gevaar te vermijden moet de externe flexibele kabel van dit apparaat, indien beschadigd, door de fabrikant, zijn technische dienst of equivalent bevoegd personeel vervangen worden.  
-Voor elke installatie of onderhoudswerkzaamheid de spanning afsluiten.  
-Het product moet door bevoegd personeel gemontereerd worden met nachtneming van de geldende normen.

 <p>0-14</p>	Aandacht! Art apparaatuur, uit de buurt van kinderen houden.		Aandacht! Gevaar voor elektrische schokken. Als geen lamp aanwezig is de stroom afsluiten.
--	--	---	--

SV Om apparatens sladd skadas ska den för att förhindra risker bytas ut av ilverkaren, kundservice eller likvärdigt kvalificerad personal.  
-Koppla alltid bort spänningen innan installation eller underhållsarbete.  
-Produkten ska monteras av kvalificerad personal som ska följa gällande inläggningsföreskrifter.

 <p>0-14</p>	Observera! Detta är ett konstföremål, inte en leksak, och ska förvaras utom räckhåll för barn.		Observera! Risk för elstöt. Koppla bort den elektriska spänningen när det saknas lampor.
--	--	---	--

NO Hvis den bøyelige ytre ledningen ved dette apparatet skades, må den ikkefles ut av produsenten eller servicetjenestene eller av tilsvarende kvalifiserte agfolk for å kunne unngå farer.  
-Koble fra spenningen før installasjon eller ethvert vedlikeholdsinngrep.

lovforskriftene overholdes.

 <p>0-14</p>	Advarsel! Kunstnerisk apparat, må holdes utenfor barns rekkevidde.		Advarsel! Fare for elektrisk støt. Koble fra den elektriske spenningen hvis lyspæren mangler.
--	--	--	---

FI Jos tämän laitteen ulkopuolinen johto vahingoittuu, vaarojen välttämiseksi se on annettava vaihdettavaksi valmistajalle tai huoltopalvelulle tai vastaavan ammattitaidon omaavalle henkilökunnalle.  
-Poista jännite ennen asennusta tai ennen minkä tahansa huoltotoimenpiteen suorittamista.  
-Tuote on asennettava ammattitaitoisen henkilökunnan toimesta voimassa olevia määräyksiä noudattaen.

 <p>0-14</p>	Varoitus! Taidelaitte, pidä lasten ulottumattomissa.		Varoitus! Sähköiskuvaara. Poista sähköjännite, kun laitteessa ei ole lampua.
---	--	---	--

PL Jeżeli przewód giętki na zewnątrz urządzenia zostanie uszkodzony, ze względów bezpieczeństwa musi zostać wymieniony przez producenta, serwis techniczny lub osobę o równorzędnych kwalifikacjach.  
-Przed przystąpieniem do instalacji lub jakiegokolwiek czynności konserwacyjnej odłączyć napięcie.  
-Produkt musi zostać zamontowany przez wykwalifikowaną osobę z obowiązującymi przepisami dotyczącymi instalacji.

 <p>0-14</p>	Uwaga! Wyrób artystyczny, przechowywać poza zasięgiem dzieci.		Uwaga! Niebezpieczeństwo porażenia prądem. W przypadku braku żarówki odłączyć od napięcia elektrycznego.
---	---	---	--

CS V případě poškození externího kabelu tohoto světidla musíte zajistit jeho výměnu prostřednictvím výrobce, technického servisu nebo kvalifikovaného technika, aby nedošlo k žádným nebezpečným situacím.  
-Před instalací a údržbou odpojte od přívodu elektrického proudu.  
-Výrobek musí namontovat kvalifikovaný technik za dodržení platných předpisů.

 <p>0-14</p>	Pozor! Umělecké světildo, uchovávejte mimo dosah dětí.		Pozor! Nebezpečí záshau elektrickým proudem. Po sejmutí žárovky odpojte světildo od přívodu elektrického proudu.
---	--	---	--

SK Ak sa poškodí externý flexibilný kábel tohto svietidla, výrobca alebo asistenčná služba alebo kvalifikovaný pracovník musí vykonať jeho výmenu za rovnaký, aby sa predišlo rizikám.  
-Pred vykonaním inštalácie alebo akejkoľvek údržby odpojte napätie.  
-Výrobok musí namontovať kvalifikovaný pracovník s dodržaním, platných noriem.

 <p>0-14</p>	Upozornenie! Meleček svetielko, držte ho z dosahu detí.		Upozornenie! Riziko zasiahnutia elektrickým prúdom. Ak sa v prístroji nenachádza žiarovka, vypnite elektrický prúd.
---	---	---	---

SL Če se zunanji prožni kabel naprave poškoduje, ga mora zamenjati proizvajalec ali serviser ali enakovredno usposobljeno oseboje in tako preprečiti nevarnost.  
-Pred namestitvijo ali kakršnim koli vzdrževanjem izklopite napajanje.  
-Proizvod mora namestiti strokovno usposobljena oseba ob upoštevanju veljavnih predpisov za namestitve.

 <p>0-14</p>	Pozor! Umetnički izdelek hranite izven dosega otrok.		Pozor! Nevarnost električnega udara. Izklopite napajanje, če žarnica ni vstavljena.
--	--	--	---

BG Ако външният гъвкав кабел на това осветително тяло бъде повреден, той трябва да се подмени от производителя, от центъра за обслужване на клиенти или от друг квалифициран персонал, за да се избегнат евентуални рискове.  
-Изключете захранването преди да извършвате операция по монтаж или поддръжка.  
-Продуктът трябва да се монтира от квалифициран персонал при спазване на съответните действащи правила и разпоредби.

 <p>0-14</p>	Внимание! Декоративно осветително тяло. Да се пази далеч от достъп на деца.		Внимание! Риск от токов удар. Изключете захранването при липса на електрическа крушка.
---	---	---	--

RO În situația în care cablul flexibil exterior al acestui aparat este deteriorat, este necesar să fie înlocuit de producător sau de serviciul de asistență ori de personal calificat echivalent, pentru a preveni aparierea pericolului.  
-Întrerupeți alimentarea cu tensiune mai înainte de a instala sau de a orice operațiune de întreținere.  
-Produsul trebuie să fie montat de personal calificat, conform standardelor în vigoare privind instalațiile.

 <p>0-14</p>	Atenție! Aparat artistic, nu lăsați la îndemâna copiilor.		Atenție! Risc de electrocutare. Întrerupeți alimentarea cu tensiune electrică în lipsa becului.
---	---	---	---

HR Ako se vanjski savitljivi kabel ovog uređaja ošteti, proizvođač ili servisna služba ili odgovarajuće osposobljeno osoblje moraju ga zamijeniti kako se ne biste izlagali mogućim opasnostima.  
-Isključite napajanje prije postavljanja ili izvođenja bilo kojeg postupka održavanja.  
-Postupak postavljanja treba obaviti osposobljeno osoblje i pritom se pridržavati važećih pripadajućih pravila.

 <p>0-14</p>	Pažnja! Budući da je riječ o zanimljivom uređaju, držite ga izvan dosega djece.		Pažnja! Rizik od strujnog udara. Isključite napajanje ako nema žarulje.
---	---	---	---

SQ Nëse kabloja fleksibël e jashtme e kësaj pajisje dëmtohet, për të shmangur rrezqet, ajo duhet të zëvendësohet nga konstruktori, shërbimi i asistencës ose nga personeli i kualifikuar ekuivalent.  
-Heqim tensionin para instalimit ose para çdo lloj mirëmbajtje.  
-Produkti duhet të montohet nga një personel i kualifikuar, duke respektuar normat në fuqi për impiantet.

 <p>0-14</p>	KUJDES! Pajisje artistike, duhet mbajtur larg nga vendet që arrihen nga fëmijët.		KUJDES! Rrezik goditje elektrike. Kur llamba nuk është e montuar, duhet të shkëputim furnizimin me energji elektrike.
---	--	---	---

SR Ako se spoljni kabl ovog uređaja ošteti, isti mora biti zamjenjen od strane proizvođača, ovlaštenog servisa ili kvalifikovanog osoblja kako bi se izbegle moguće opasnosti.  
-Pre ugradnje ili bilo kakvog održavanja, isključiti struju.  
-Proizvod mora biti montiran od strane kvalifikovanog osoblja, u skladu sa važećim propisima.

 <p>0-14</p>	Pažnja! Umetnički komad. Držite ga dalje od dohvata dece.		Pažnja! Rizik od strujnog udara. Isključiti iz struje kada u uređaju nema sijalice.
---	---	---	---

TR Bu cihazın dış esnek kablosunun hasar görmesi halinde, tehnikelerin önlenmesi amacıyla, işbu kablo imalatçı veya teknik servis ya da eşdeğer kalifiye personel tarafından değiştirilmelidir.  
-Kurulumdan önce herhangi bir bakım işleminden önce gerilimi kesiniz.  
-Ürün, yürürlükteki yetklimeliklere uygun olarak, kalifiye personel tarafından monte edilmelidir.

 <p>0-14</p>	Dikkat! Dekoratif cihaz, çocukların ulaşamayacağı yerlerde saklayınız.		Dikkat! Elektrik çarpması riski. Ampul yoksa elektrik gerilimini kesiniz.
---	--	---	---

SH Ako je oštećen vanjski savitljivi kabl ovog uređaja mora biti zamjenjen od strane proizvođača ili odgovarajućeg servisnog centra ili kvalifikovanog osoblja kako bi se izbjegla opasnost.  
-Isključite napajanje prije instalacije ili bilo kakvog održavanja.  
-Proizvod mora biti montiran od strane kvalifikovanog osoblja, u skladu sa važećim propisima.

 <p>0-14</p>	Upozorenje! Umjetnički uređaj, držati podalje od djece.		Upozorenje! Rizik od strujnog udara. Isključite napajanje strujom u odsustvu sijalice.
---	---	---	--

EL Εάν το εξωτερικό ευκαμπτό καλώδιο αυτής της συσκευής έχει υποστεί ζημιά, θα πρέπει να αντικατασταθεί από τον κατασκευαστή ή το σέρβις ή από προσόντοχο προσωπικό, προκειμένου να αποφευχθεί τυχόν κίνδυνος.  
-Αφαιρέστε την τάση πριν από την εγκατάσταση ή από οποιοδήποτε συντήρηση.  
-Το προϊόν πρέπει να εγκατασταθεί από εξειδικευμένο προσωπικό, σύμφωνα με τους κανονισμούς εγκατάστασης.

 <p>0-14</p>	Προσοχή! Καλλιτεχνική συσκευή, να φυλάσσεται μακριά από παιδιά.		Προσοχή! Ένδειξη κίνδυνος ηλεκτροπληξίας. Αποσυνδέστε την παροχή ηλεκτρικού ρεύματος σε περίπτωση απουσίας του λαμπτήρα.
---	---	---	--

RU Если у данного прибора окажется поврежденными наружные шнуры, то, во избежание риска, обратиться за его заменой к изготовителю, либо в сервисный центр, либо к обладателю необходимого квалификационного мастеру.  
-Перед осуществлением монтажа и любого технического обслуживания отключайте напряжение.  
-Установка прибора должна осуществляться квалифицированными мастерами в соответствии с действующими правилами электромонтажа.

 <p>0-14</p>	Внимание! Данное художественное изделие необходимо хранить в недоступном для детей месте.		Внимание! Риск поражения электрическим током. При отстутствии лампочки отключайте электроннапряжение.
---	---	---	---



UK Якщо зовнішній гнучкий кабель чи шнур світільного пошкоджено, його має замінити виробник чи представник служби обслуговування або особа з відповідною кваліфікацією, щоб уникнути небезпек.  
-Перш ніж встановлювати виріб або проводити будь-які дії з технічного обслуговування, слід від'єднати світільник від джерела живлення.  
-Виріб має встановлюватися кваліфікованим спеціалістом відповідно до діючих стандартів.

 <p>0-14</p>	Uwaga! Artystyczny wyrób. Trzymajcie go daleko od dzieci.		Uwaga! Niebezpieczeństwo ураження електричним струмом. Від'єднати світільник від джерела живлення якщо електрична лампочка відсутня.
---	---	---	--

LV Ja šai ierīcei ir bojāts ārējais lokālais vads, tā nomaiņa jāuztāt ražotājam, servīsa centra speciālistam vai darbiniekam ar līdzīgu kvalifikāciju, lai izvairītos no briesmām.  
-Pirms uzstādīšanas vai jebkādu apkopes darbu veikšanas atslēdziet strāvas padevi.  
-Produktu uzstādīšana jāuztāt kvalificētam speciālistam, kuram jāievēro spēkā esošie noteikumi elektroinstalācijas darbu jomā.

 <p>0-14</p>	Uzmanību! Mākslas izstrādājums, turēt bērniem neaizsiedzamā vietā.		Uzmanību! Elektriskās strāvas trieciena risks. Atslēdziet strāvas padevi, ja nav uzstādīta spuldze.
---	--	---	---

EN Per isonin tarkistus suo pretään laadus ylä pæraistis, jll tll paketsi gamintojas, tehniñes priežišros paslaugtu teikėjai arba atitinkami kvalifikuoti darbuotojai, kad būtų išvengta pavojų.  
-Prieš įrengimą ar bet kokią techninę priežiūrą išjunkite srovės šaltinį.  
-Gaminių turi įrengti kvalifikuoti darbuotojai, laikydamiesi galiojančių įrenginių įrengimo taisyklių.

 <p>0-14</p>	Atsargiai! Tai meninis įrenginys, saugoti nuo vaikų.		Atsargiai! Elektros smūgio pavojus. Nesant lemputės, išjunkite srovės šaltinį.
---	--	---	--



ET Kui seadme väline painduv juhe saab kahjustada, peab selle ohtude vältimiseks välja vahetama kas toote valmistaja, teenuskeskus või samasuguse kvalifikatsiooniga töötaja.  
-Paigaldamisel või enne mis tahes hoolduse tegemist eemaldage seade elektrivõrgust.  
-Toote tohib paigaldada ainult asjakohaste kutseoskustega töötaja, kes järgib seadmete tehnikaid ettekirjutusi.

 <p>0-14</p>	Tähelepanu! See on kunstiline seade, mitte mänguasi. Hoida lastele kättesaamatus kohas.		Tähelepanu! Elektrilöögi oht. Kui elektripirn ei ole paigaldatud, siis ärge seadet elektrivõrku ühendage.
---	---	---	---



ZH 若本设备的外接柔性电线受损，必须由制造商、售后服务方或具有相同资质的专业人员更换，以避免发生事故。安装或维修前请切断电源。本设备需由专业人员遵照相关规定进行安装。

 <p>0-14</p>	请注意！本设备为工艺品，请放在远离儿童的地方。		请注意！小心触电。无灯泡时请务必切断电源。
---	-------------------------	---	-----------------------

KO 본 기기의 외부 전선 케이블이 손상된 경우, 위험을 방지하기 위해 제조사 또는 서비스 센터 또는 이와 동등한 자격을 갖춘 전문가에 의해 교체해야 합니다. 어떠한 경우라도 기기를 보수하거나 설치 시에는 전원을 차단해야 합니다. 이 제품의 준비가 된 자격을 갖춘 전문가에 의해 설치 규정을 준수하여 설치되어야 합니다.

 <p>0-14</p>	주의! 디자인 기기가 어린이의 주의를 끌기 쉬우나, 어린이의 손이 닿지 않는 곳에 보관하십시오.		주의! 감전 위험이 있습니다. 기기에 전구가 설치되지 않은 상태에서 전원을 차단하십시오.
---	---	---	---

JA 外部ケーブルが損傷した場合の交換は、危険を避けるため、生産者かアフターサービス、または同等の有資格者が行ってください。取り替えを含むあらゆるメンテナンスをする際は、必ず電源をお切りください。



 <p>0-14</p>	注意！デザイン器具ですので、お子様の手の届かないところで使用ください。		注意！感電の恐れがあります。電球を取り外した際、電源をお切りください。
---	-------------------------------------	---	-------------------------------------

HI खतरे से बचने के लिए उपकरण का क्षतियुक्त वाहरी लचीला तार निमाता या बिक्री के उपरालत सर्बिा कर्मचारियों द्वारा ही बदला जाना चाहिए। तार बदलने के पहले या रखरखाव के किसी भी कार्य से पहले विजली बंद कर दें। प्रोडक्ट योग्य कर्मचारियों द्वारा ही नियमातुसार तरीकेसे इन्स्टॉल किया जाना चाहिए।

 <p>0-14</p>	सावधान! उपकरण कलात्मक है अतः बच्चों से दूर रखें।		सावधान! विजली के झटके का खतरा है। बल्ब न होने पर विजली की आपूर्ति काट दें।
---	--	---	--

HE אם הכבל הגמיש החיצוני של מוסכמים זה פגום, היצורן להחליפו או שירות התמיכה או אנשים מוסכמים הרשים להחליפו. כדי למנוע סכנה יש לנתק את אספקת החשמל לפני תזקנה או תחזוקה כשהי

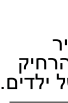
תזקנת המוצר תבוצע על ידי אנשים מוסכמים בלבד, והתאם לתקנות הוהרות בנושא מתקנים.

 <p>0-14</p>	אזהרה! סכנת התחשמלות. אזהרה! מכשיר בהיעדר נורה יש לנתק את אספקת החשמל. אמונותי יש להרחיק מהישג ידם של ילדים.	
---	--	---

AR إذا تعرض السلك الخارجي المرن للجهاز إلى التلف فيجب استبداله من قبل الشركة لصنع أو مركز خدمة المساء عدة أو من قبل عمال مؤهلين من نوي الخبرة، ذلك تجنباً للتعرض إلى المخاطر. يجب فصل المنتج عن التيار الكهربائي عند التركيب عند القيام بأية عملية من عمليات الصيانة. يجب أن يكون عمال مؤهلون بتركيب المنتج ويجب أن يتم هذا بالاستناد إلى التوجيهات سارية الخاصة بالأجهزة.

 <p>0-14</p>	تنبيه! هذا الجهاز هو قطعة فنية ويجب فصل الجهاز عن التيار الكهربائي عند عدم وجود المصباح الكهربائي.	
---	--	---

# C-01

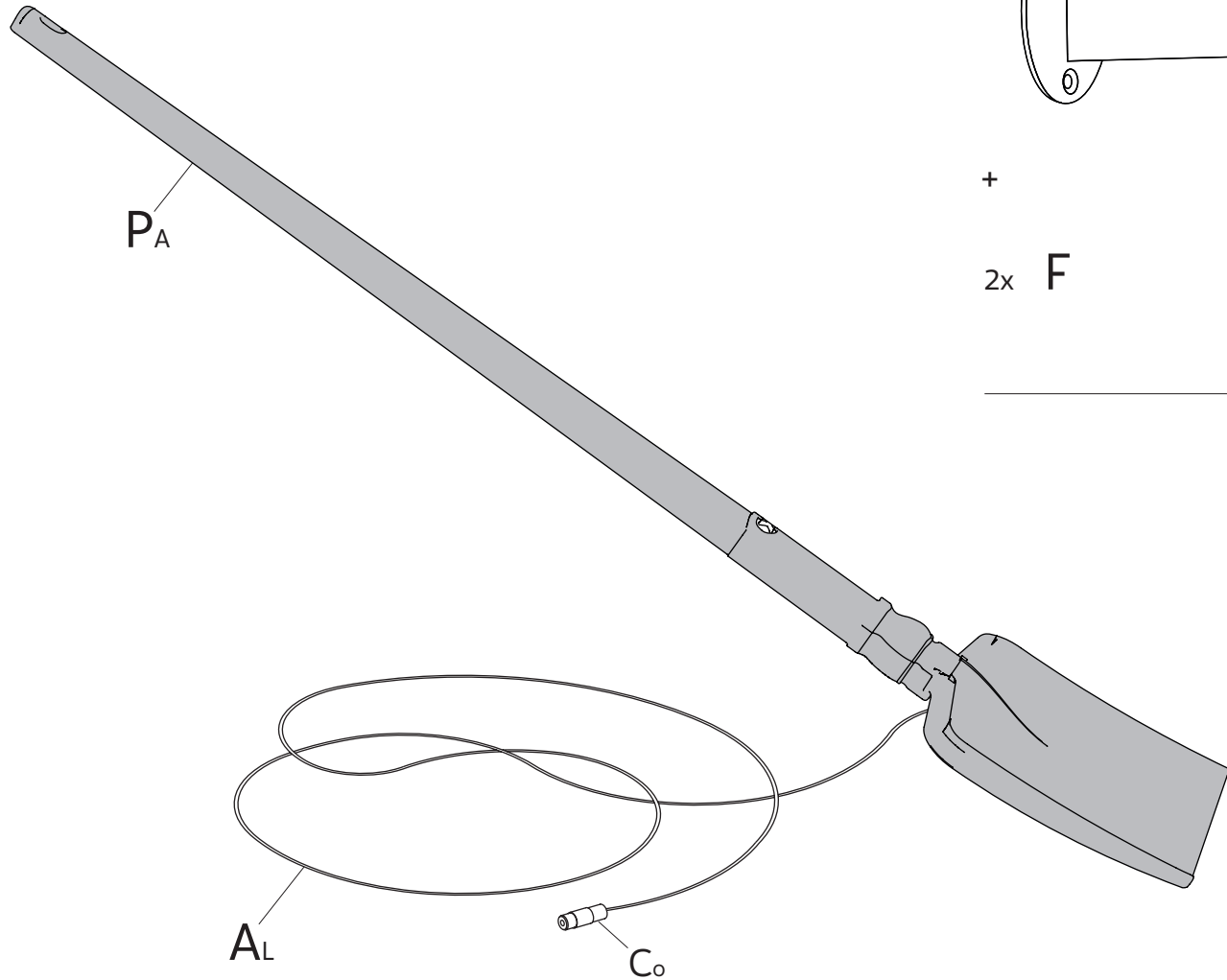

1x AC145 4A INT

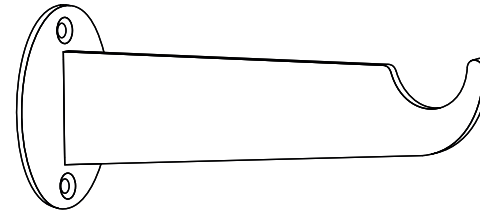

+

2x F



1x AC145 5A INT

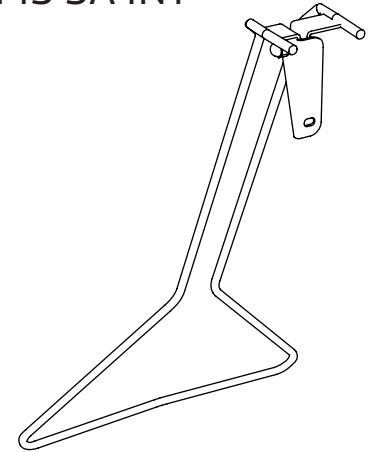

+

1x Vac



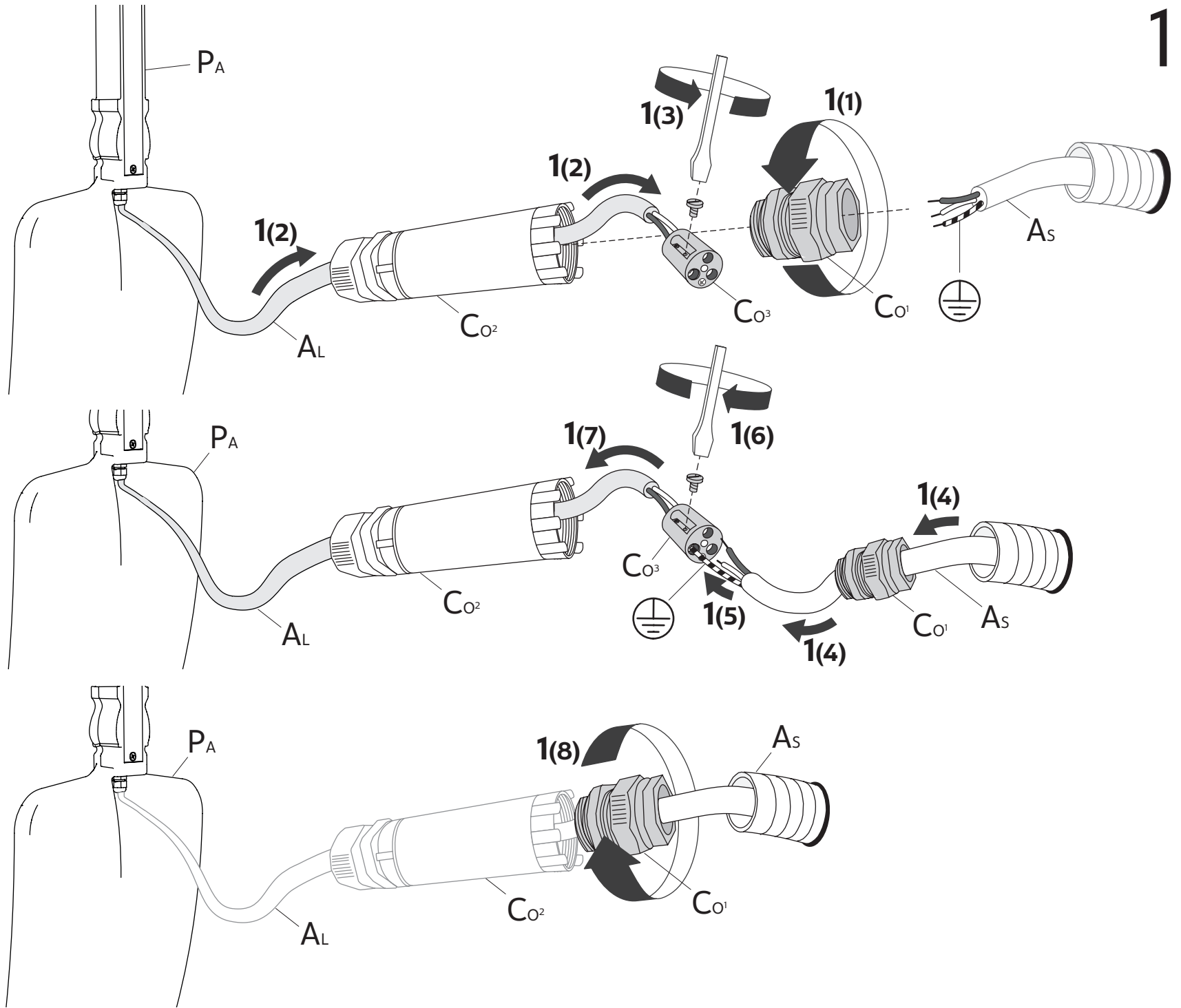
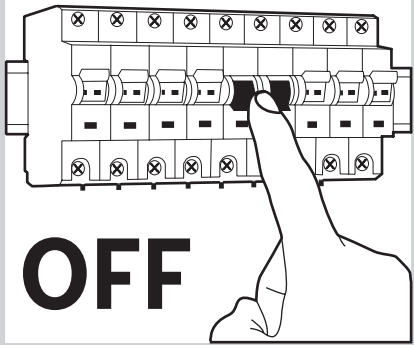

AC145 5A INT

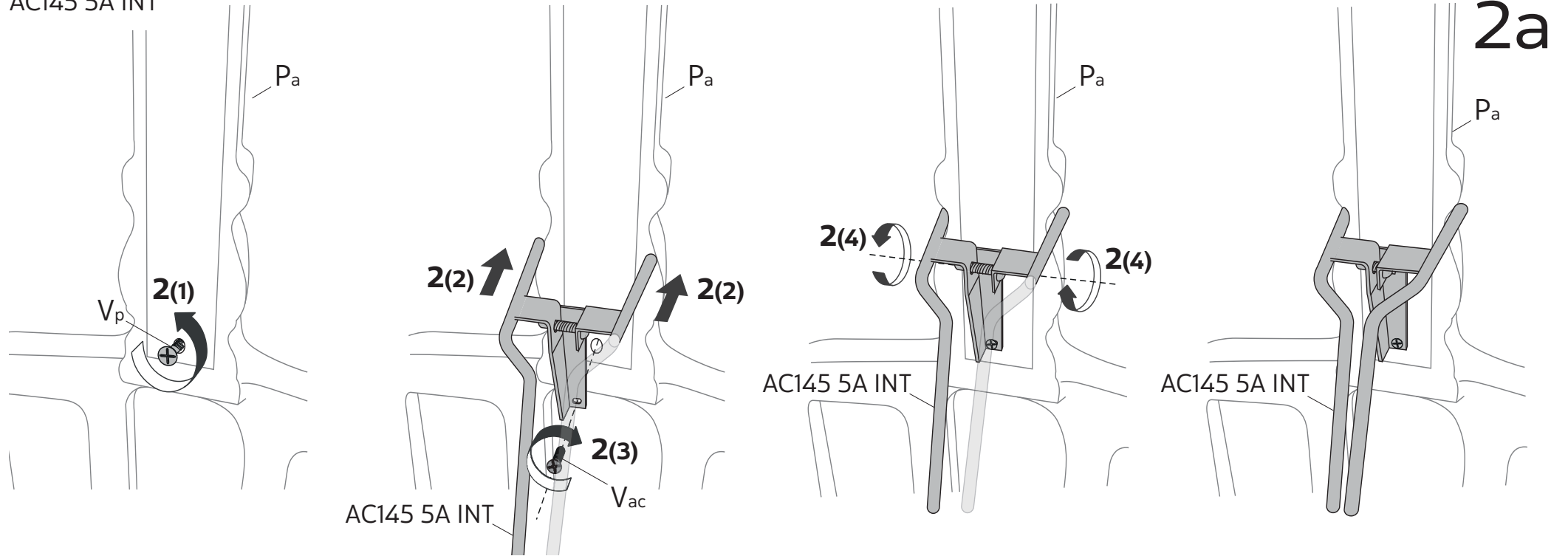

AC145 4A INT

